



**AGRICULTURAL
HOSE & COUPLINGS
GUIDE**

**JASON[®]
INDUSTRIAL**

Jason Industrial® is a member of the Ammega Group. Ammega Group companies manufacture, fabricate and supply Power Transmission Belting, Material Handling Hoses and Accessories for a wide range of industries.

This brochure presents Jason Industrials' portfolio of hose and accessories that serve the needs of the Agricultural and Lawn & Garden markets.

As our customer you can feel confident in the quality and integrity of our products, the speed and efficiency at which they are delivered, along with the expertise and customer focus that we are committed to providing.

Our US Headquarters is located in Fairfield, NJ. Customer Service and our Distribution Center are located just outside of Chicago, IL.

For more information on Jason Industrial's portfolio, visit www.jasonindustrial.com



WARNING: This catalog contains products that can expose you to chemicals including carbon black, DINP, DIDP, DEHP, DBP, DNHP, BBP, lead and/or styrene which is known in the state of California to cause cancer, birth defects or other reproductive harm. For more information visit www.P65WARNINGS.ca.gov

Air Hose	2
<i>Polyurethane</i>	
<i>SBR</i>	
<i>PVC</i>	
Farm Tank Hose	3
Fuel Nozzles, Swivels & Accessories	4-5
Hydraulic Hose & Accessories	6-7
<i>(Available with solid and solid/swivel ends.)</i>	
Hydraulic Fittings & Adapters	8-13
Pump Hoses, Strainers & Accessories	14-20
<i>Discharge</i>	
<i>Suction</i>	
<i>Suction: Food Grade</i>	
<i>Fertilizer Solution</i>	
<i>Strainers</i>	
Couplings	21-25
<i>Cam & Groove: Aluminum/Polypropylene</i>	
<i>Dust Caps</i>	
<i>Dust Plugs</i>	
<i>Rubber Gaskets</i>	
<i>Combination Hose Nipples</i>	
Tubing & Hose	26-27
<i>Braided PVC</i>	
<i>EVA</i>	
<i>EPDM</i>	
Terms, Conditions and Limited Warranty of Sale	28

AIR HOSE

POLYURETHANE - COLD WEATHER



Features

- 75% lighter than rubber and 65% lighter than PVC
- Flexible to -40°F (-40°C)
- Resists kinking
- Oil and solvent resistant
- Bend restrictor

Specifications

Material - Polyurethane

Working Pressure - 200 PSI

Burst Pressure - 800 PSI

UV Stabilized - Yes



WARNING: This product can expose you to chemicals including DINP, which is known to the State of California to cause cancer or birth defects or other reproductive harm. For more information visit www.P65WARNINGS.ca.gov

PART NUMBER	UPC	SIZE	LENGTH
4175-0025-025MS	746041060725	1/4"	25'
4175-0025-050MS	746041058944	1/4"	50'
4175-0025-100MS	746041058951	1/4"	100'
4175-0038-050MS	746041060732	3/8"	50'

SBR



Features

- Coupled male brass ends

Specifications

Material - SBR rubber

Working Pressure - 300 PSI



WARNING: This product can expose you to chemicals including carbon black, which is known to the State of California to cause cancer or birth defects or other reproductive harm. For more information visit www.P65WARNINGS.ca.gov

PART NUMBER	UPC	SIZE	LENGTH
4120-037450	7406041055240	3/8"	50'

PVC



Features

- Coupled male brass ends
- Bend restrictor

Specifications

Material - PVC

Working Pressure - 300 PSI



WARNING: This product can expose you to chemicals including DINP, which is known to the State of California to cause cancer or birth defects or other reproductive harm. For more information visit www.P65WARNINGS.ca.gov

PART NUMBER	UPC	SIZE	LENGTH
4103-025406	746041056360	1/4"	6'
4103-025425	746041020576	1/4"	25'
4103-025450	746041020569	1/4"	50'
4103-037425	746041020590	3/8"	25'
4103-037450	746041020583	3/8"	50'

FARM TANK FUEL TRANSFER HOSE - BLACK

Features

- Class A (low permeation) tube
- 2-spiral, high tensile polyester reinforced
- Internal spring guards prevent kinking
- Internal static wire
- Up to 15% Ethanol or Bio-Diesel

Specifications

Material: NBR, RMA CLASS A

Working Pressure: 60 PSI

Burst Pressure: 240 PSI

Temperature: -20°F (-29°C) to +160°F (+71°C)



WARNING: This product can expose you to chemicals including carbon black, which is known to the State of California to cause cancer or birth defects or other reproductive harm. For more information visit www.P65WARNINGS.ca.gov



PART NUMBER	UPC	SIZE
4126-07510AP	746041019280	3/4" x 10'
4126-07512AP	746041019297	3/4" x 12'
4126-07514AP	746041019303	3/4" x 14'
4126-07515AP	746041019310	3/4" x 15'
4126-07520AP	746041019327	3/4" x 20'

PART NUMBER	UPC	SIZE
4126-10010AP	746041019341	1" x 10'
4126-10012AP	746041019358	1" x 12'
4126-10014AP	746041019365	1" x 14'
4126-10015AP	746041019372	1" x 15'
4126-10020AP	746041019389	1" x 20'

FARM TANK FUEL TRANSFER HOSE - GREEN

Features

- Class A (low permeation) tube
- 2-spiral, high tensile polyester reinforced
- Internal spring guards prevent kinking
- Internal static wire
- Up to 15% Ethanol or Bio-Diesel

Specifications

Material: NBR, RMA CLASS A

Working Pressure: 60 PSI

Burst Pressure: 240 PSI

Temperature: -20°F (-29°C) to +160°F (+71°C)



WARNING: This product can expose you to chemicals including carbon black, which is known to the State of California to cause cancer or birth defects or other reproductive harm. For more information visit www.P65WARNINGS.ca.gov



PART NUMBER	UPC	SIZE
4127-07510AP	746041055501	3/4" x 10'
4127-07512AP	746041054915	3/4" x 12'
4127-07514AP	746041055028	3/4" x 14'
4127-07515AP	746041054922	3/4" x 15'
4127-07520AP	746041055035	3/4" x 20'

PART NUMBER	UPC	SIZE
4127-10010AP	746041055042	1" x 10'
4127-10012AP	746041054939	1" x 12'
4127-10014AP	746041055059	1" x 14'
4127-10015AP	746041054946	1" x 15'
4127-10020AP	746041055066	1" x 20'

FUEL NOZZLES, SWIVELS & ACCESSORIES

MANUAL (GRAVITY FLOW) FUEL NOZZLE WITH INLET SWIVEL



Application: For off-road and farm equipment from a gravity flow tank. For use with gasoline, kerosene, diesel and most petroleum-based products.

Construction: Lightweight aluminum body. Unique level handle design for smooth ease of handling flow control. Makes topping off easy. Features a brass 360° rotary inlet swivel. Shuts off with minimal line shock.

PART NUMBER	UPC	SIZE
A2000-075	746041061739	3/4" INLET x 13/16" SPOUT
A2000-100	746041061678	1" INLET x 1" SPOUT



WARNING: This product can expose you to chemicals including lead, which is known to the State of California to cause cancer or birth defects or other reproductive harm. For more information visit www.P65WARNINGS.ca.gov

AUTOMATIC SHUT-OFF FUEL NOZZLES



WARNING: This product can expose you to chemicals including lead, which is known to the State of California to cause cancer or birth defects or other reproductive harm. For more information visit www.P65WARNINGS.ca.gov

Application: Perfect for those looking for a quality, economical nozzle. For use with gasoline, 15% ethanol, diesel, 20% bio-blend.

Construction: 3/4" inlet NPT, 13/16" spout. Flow rate 14 GPM. Hold open handle clip for fast, effortless self-setting filling convenience. Lightweight, low-profile aluminum body and full hand insulator that protects the nozzle, vehicle and user's hand.

Features: 15 PSI is required to operate auto-shut off. Nozzle shuts off at 3 GPM.

PART NUMBER	UPC	SIZE
A2100-07513	746041061715	3/4" INLET NPT x 13/16" SPOUT



WARNING: This product can expose you to chemicals including lead, which is known to the State of California to cause cancer or birth defects or other reproductive harm. For more information visit www.P65WARNINGS.ca.gov

Application: With quality and economic features of A2100-07513, increased flow rate is the added (universal) feature of this nozzle.

Construction: 3/4" inlet NPT, 15/16" spout. Flow rate 18 GPM. Hold open handle clip for fast, effortless self-setting filling convenience. Lightweight, low-profile aluminum body and full hand insulator that protects the nozzle, vehicle and user's hand.

Features: 15 PSI is required to operate auto-shut off. Nozzle shuts off at 3 GPM.

PART NUMBER	UPC	SIZE
A2100-07515	746041061722	3/4" INLET NPT x 15/16" SPOUT



WARNING: This product can expose you to chemicals including lead, which is known to the State of California to cause cancer or birth defects or other reproductive harm. For more information visit www.P65WARNINGS.ca.gov

Application: A true "Universal" nozzle that matches user convenience with full flow rates.

Construction: 1" inlet NPT, 1" spout. Flow rate 22 GPM. Unique new 3-stage flow set trigger concealed within the handle for remarkable operating ease. Ultra-lightweight aluminum body and full hand insulator that protects the nozzle, vehicle and user's hand.

Features: 15 PSI is required to operate auto-shut off. Nozzle shuts off at 3 GPM.

PART NUMBER	UPC	SIZE
A2111-100	746041062231	1" INLET NPT x 1" SPOUT



WARNING: This product can expose you to chemicals including lead, which is known to the State of California to cause cancer or birth defects or other reproductive harm. For more information visit www.P65WARNINGS.ca.gov

Application: For Heavy Duty, Max-Flow Truck, Bus and Fleet Service. This Pro-Flo design and durability provides a high-volume flow nozzle that helps increase productivity.

Construction: 1" inlet NPT, 1-3/16" spout. Flow rate 32 GPM. Hold open handle clip for fast, effortless self-setting filling convenience. Lightweight, low profile aluminum body and full hand insulator that protects the nozzle, vehicle and user's hand.

Features: 15 PSI is required to operate auto-shut off. Nozzle shuts off at 3 GPM.

PART NUMBER	UPC	SIZE
A2200-100	746041061708	1" INLET NPT x 1-3/16" SPOUT

45° TRUCK STOP SWIVEL

Application: Designed for self-service where easy nozzle and hose handling is important for user convenience. It is installed between the nozzle and hose to reduce strain, provide flexibility in hose to nozzle positioning for twist, kink-free hose movement.

Construction: Aluminum, double-swivel, 45° angled with brass adapter, all Viton seals.

PART NUMBER	UPC	SIZE
A1045-075	746041061685	3/4" MALE x FEMALE PIPE THREAD THREAD
A1045-100	746041061692	1" MALE x FEMALE PIPE THREAD THREAD



WARNING: This product can expose you to chemicals including lead, which is known to the State of California to cause cancer or birth defects or other reproductive harm. For more information visit www.P65WARNINGS.ca.gov

UNIVERSAL (FULL CIRCLE) SWIVELS

Application: Swivel is designed for use between hose and nozzle. The full-circle swivel reduces physical strain by aligning nozzle with fill-pipe. Thread combinations adapt to all size combinations between hose and nozzle.

Construction: Aluminum body, brass plated swivel bushing, Viton and Buna-N seals.

PART NUMBER	UPC	SIZE
701	746041061746	3/4" NPT MALE x 3/4" NPT FEMALE
703	746041061753	3/4" NPT MALE x 1" NPT FEMALE
709	746041061760	1" NPT MALE x 3/4" NPT FEMALE
711	746041061777	1" NPT MALE x 1" NPT FEMALE



WARNING: This product can expose you to chemicals including lead, which is known to the State of California to cause cancer or birth defects or other reproductive harm. For more information visit www.P65WARNINGS.ca.gov

NOZZLE SPLASH GUARDS

PART NUMBER	UPC	DESCRIPTION
SG-R	746041061784	UNLEADED SPLASH GUARD
SG-G	746041061791	DIESEL SPLASH GUARD
SG-Y	746041061807	MANUAL OR FARM FUEL SPLASH GUARD



WARNING: This product can expose you to chemicals including DINP, which is known to the State of California to cause cancer or birth defects or other reproductive harm. For more information visit www.P65WARNINGS.ca.gov



HYDRAULIC HOSE & ACCESSORIES



Color-coded labels make product identifying easy!

GOLD - 1/4" x SOLID

BROWN - 3/8" x SOLID

GREEN - 1/2" x SOLID

SILVER - 3/4" x SOLID

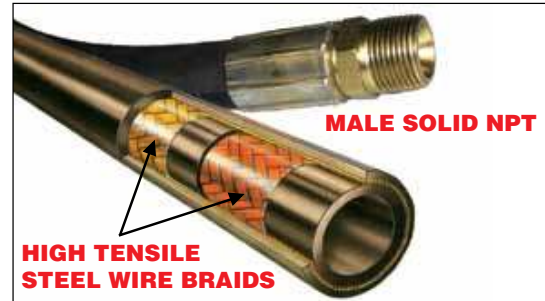

MALE SOLID NPT x MALE SOLID NPT



WARNING: This product can expose you to chemicals including carbon black, which is known to the State of California to cause cancer or birth defects or other reproductive harm. For more information visit www.P65WARNINGS.ca.gov

1/4"

2-Wire Braid

5800 PSI W.P.

PART NUMBER	UPC	SIZE	PART NUMBER	UPC	SIZE
4920-0025-0012P	746041064105	1/4" x 12"	4920-0025-0036P	746041055271	1/4" x 36"
4920-0025-0018P	746041055257	1/4" x 18"	4920-0025-0048P	746041055288	1/4" x 48"
4920-0025-0024P	746041055264	1/4" x 24"	4920-0025-0060P	746041055295	1/4" x 60"
4920-0025-0030P	746041063962	1/4" x 30"	4920-0025-0072P	746041064488	1/4" x 72"

3/8"

2-Wire Braid

4500 PSI W.P.

PART NUMBER	UPC	SIZE	PART NUMBER	UPC	SIZE
4920-0038-0012P	746041021443	3/8" x 12"	4920-0038-0072P	746041021283	3/8" x 72"
4920-0038-0018P	746041021450	3/8" x 18"	4920-0038-0084P	746041021467	3/8" x 84"
4920-0038-0024P	746041021221	3/8" x 24"	4920-0038-0096P	746041021290	3/8" x 96"
4920-0038-0030P	746041021849	3/8" x 30"	4920-0038-0108P	746041021306	3/8" x 108"
4920-0038-0036P	746041021269	3/8" x 36"	4920-0038-0120P	746041021474	3/8" x 120"
4920-0038-0048P	746041021276	3/8" x 48"	4920-0038-0144P	746041021313	3/8" x 144"
4920-0038-0060P	746041021238	3/8" x 60"	4920-0038-0168P	746041054953	3/8" x 168"

1/2"

2-Wire Braid

3500 PSI W.P.

PART NUMBER	UPC	SIZE	PART NUMBER	UPC	SIZE
4920-0050-0012P	746041021481	1/2" x 12"	4920-0050-0084P	746041021184	1/2" x 84"
4920-0050-0018P	746041021498	1/2" x 18"	4920-0050-0096P	746041021191	1/2" x 96"
4920-0050-0024P	746041021320	1/2" x 24"	4920-0050-0108P	746041021207	1/2" x 108"
4920-0050-0030P	746041021788	1/2" x 30"	4920-0050-0120P	746041021252	1/2" x 120"
4920-0050-0036P	746041021245	1/2" x 36"	4920-0050-0132P	746041021764	1/2" x 132"
4920-0050-0042P	746041021771	1/2" x 42"	4920-0050-0144P	746041021214	1/2" x 144"
4920-0050-0048P	746041021887	1/2" x 48"	4920-0050-0168P	746041021801	1/2" x 168"
4920-0050-0060P	746041021160	1/2" x 60"	4920-0050-0180P	746041021818	1/2" x 180"
4920-0050-0072P	746041021177	1/2" x 72"	4920-0050-0192P	746041021924	1/2" x 192"

3/4"

2-Wire Braid

3118 PSI W.P.

PART NUMBER	UPC	SIZE	PART NUMBER	UPC	SIZE
4920-0075-0024P	746041054977	3/4" x 24"	4920-0075-0072P	746041064099	3/4" x 72"
4920-0075-0036P	746041054984	3/4" x 36"	4920-0075-0096P	746041064082	3/4" x 96"
4920-0075-0048P	746041054991	3/4" x 48"	4920-0075-0120P	746041064075	3/4" x 120"
4920-0075-0060P	746041062866	3/4" x 60"			



- RED - 3/8" x SWIVEL
- PURPLE - 1/2" x SWIVEL
- ORANGE - 3/4" x SWIVEL

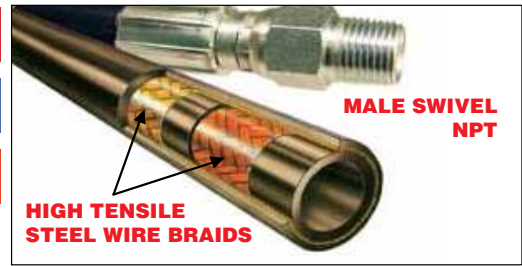

MALE SOLID NPT x MALE SWIVEL NPT



WARNING: This product can expose you to chemicals including carbon black, which is known to the State of California to cause cancer or birth defects or other reproductive harm. For more information visit www.P65WARNINGS.ca.gov

3/8"

2-Wire Braid

4500 PSI W.P.

PART NUMBER	UPC	SIZE
4921-0038-0012P	746041062781	3/8" x 12"
4921-0038-0018P	746041053307	3/8" x 18"
4921-0038-0024P	746041053314	3/8" x 24"
4921-0038-0030P	746041053321	3/8" x 30"
4921-0038-0036P	746041053338	3/8" x 36"
4921-0038-0048P	746041053345	3/8" x 48"
4921-0038-0060P	746041053352	3/8" x 60"
4921-0038-0072P	746041053369	3/8" x 72"

PART NUMBER	UPC	SIZE
4921-0038-0084P	746041053376	3/8" x 84"
4921-0038-0096P	746041053383	3/8" x 96"
4921-0038-0108P	746041053390	3/8" x 108"
4921-0038-0120P	746041053406	3/8" x 120"
4921-0038-0132P	746041053413	3/8" x 132"
4921-0038-0144P	746041053420	3/8" x 144"
4921-0038-0168P	746041064082	3/8" x 168"

1/2"

2-Wire Braid

3500 PSI W.P.

PART NUMBER	UPC	SIZE
4921-0050-0012P	746041053437	1/2" x 12"
4921-0050-0018P	746041053444	1/2" x 18"
4921-0050-0024P	746041053451	1/2" x 24"
4921-0050-0030P	746041053468	1/2" x 30"
4921-0050-0036P	746041053475	1/2" x 36"
4921-0050-0048P	746041053499	1/2" x 48"
4921-0050-0060P	746041053505	1/2" x 60"
4921-0050-0072P	746041053512	1/2" x 72"
4921-0050-0084P	746041053529	1/2" x 84"

PART NUMBER	UPC	SIZE
4921-0050-0096P	746041053536	1/2" x 96"
4921-0050-0108P	746041053543	1/2" x 108"
4921-0050-0120P	746041053550	1/2" x 120"
4921-0050-0132P	746041053567	1/2" x 132"
4921-0050-0144P	746041053574	1/2" x 144"
4921-0050-0168P	746041053598	1/2" x 168"
4921-0050-0180P	746041053604	1/2" x 180"
4921-0050-0192P	746041053611	1/2" x 192"

3/4"

2-Wire Braid

3118 PSI W.P.

PART NUMBER	UPC	SIZE
4921-0075-0012P	746041065195	3/4" x 12"
4921-0075-0018P	746041065201	3/4" x 18"
4921-0075-0024P	746041064549	3/4" x 24"
4921-0075-0036P	746041064556	3/4" x 36"
4921-0075-0048P	746041064563	3/4" x 48"

PART NUMBER	UPC	SIZE
4921-0075-0060P	746041064570	3/4" x 60"
4921-0075-0072P	746041065218	3/4" x 72"
4921-0075-0096P	746041065225	3/4" x 96"
4921-0075-0120P	746041065232	3/4" x 120"

GREASE GUN HOSE (WHIP) - 3000 PSI W.P.



WARNING: This product can expose you to chemicals including carbon black, which is known to the State of California to cause cancer or birth defects or other reproductive harm. For more information visit www.P65WARNINGS.ca.gov

PART NUMBER	UPC	SIZE
GWH1200	746041059422	3/16" x 12"
GWH1800	746041059439	3/16" x 18"
GWH2400	746041059446	3/16" x 24"
GWH3600	746041059453	3/16" x 36"



Adapter Nomenclature

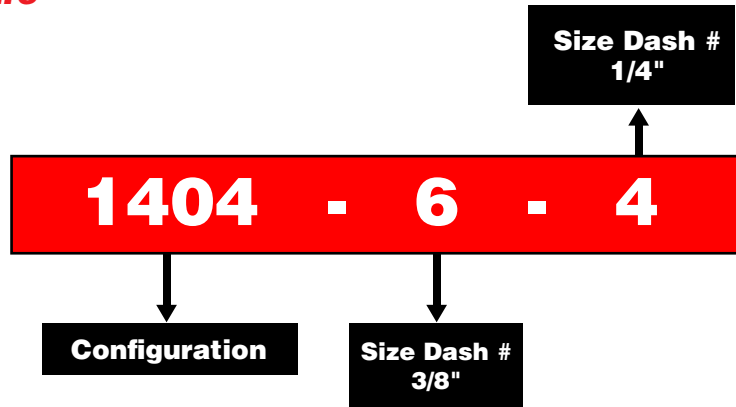
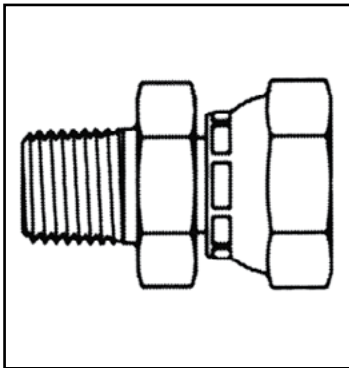

CONFIGURATION	TYPE	DESCRIPTION
1404	MP-FPX	MALE X FEMALE STRAIGHT ADAPTERS
1405	FP-FPX	FEMALE X FEMALE STRAIGHT ADAPTERS
1406	FPX-FPX	FEMALE X FEMALE STRAIGHT ADAPTERS
1501	MP-FPX	90° ADAPTERS
1502	FP-FPX	90° ADAPTERS
1503	MP-FPX	45° ADAPTERS
2403	MJ-MJ	MALE X MALE STRAIGHT ADAPTERS
2404	MJ-MP	MALE X MALE STRAIGHT ADAPTERS
2405	MJ-FP	MALE X FEMALE STRAIGHT ADAPTERS
2501	MJ-MP	90° ADAPTERS
5406	MP-FP	REDUCER BUSHINGS
5504	FP-FP	90° ADAPTERS
5605	FP-FP-FP	TEE ADAPTERS
6401	MORB-MP	MALE X MALE STRAIGHT ADAPTERS
6404	FORB-MP	FEMALE X MALE STRAIGHT ADAPTERS
6405	MORB-FP	MALE X FEMALE STRAIGHT ADAPTERS
6410	MORB-FORB	MALE X FEMALE STRAIGHT ADAPTERS
6420	FP-FORB	FEMALE X FEMALE STRAIGHT ADAPTERS
6425	FORB-FORB	FEMALE X FEMALE STRAIGHT ADAPTERS
6506	FP-FJX	FEMALE X FEMALE STRAIGHT ADAPTERS
6900	MORB-FPX	MALE X FEMALE STRAIGHT ADAPTERS
6901	MORB-FPX	90° ADAPTERS
6902	MORB-FPX	45° ADAPTERS

CODE	THREAD CONFIGURATION
B	ORing Boss
F	Female
J	JIC Thread
M	Male
OR	ORing
P	Pipe Thread NPTF or NPSM
R	Restricted Orifice
X	Swivel

SIZE DASH #	THREAD CONFIGURATION
-2	1/8"
-3	3/16"
-4	1/4"
-5	5/16"
-6	3/8"
-8	1/2"
-10	5/8"
-12	3/4"

PART NUMBER	UPC	DESCRIPTION
1404-4-4	746041054441	1/4" ML PIPE x 1/4" FEM PIPE SWIVEL
1404-4-6	746041056421	1/4" ML PIPE x 3/8" FEM PIPE SWIVEL
1404-6-4	746041056438	3/8" ML PIPE x 1/4" FEM PIPE SWIVEL
1404-6-6	746041054434	3/8" ML PIPE x 3/8" FEM PIPE SWIVEL
1404-6-8	746041054458	3/8" ML PIPE x 1/2" FEM PIPE SWIVEL
1404-8-4	746041056445	1/2" ML PIPE x 1/4" FEM PIPE SWIVEL
1404-8-6	746041054465	1/2" ML PIPE x 3/8" FEM PIPE SWIVEL
1404-8-8	746041054496	1/2" ML PIPE x 1/2" FEM PIPE SWIVEL
1404-12-8	746041056469	3/4" ML PIPE x 1/2" FEM PIPE SWIVEL
1404-12-12	746041055356	3/4" ML PIPE x 3/4" FEM PIPE SWIVEL



WARNING: This product can expose you to chemicals including lead, which is known to the State of California to cause cancer or birth defects or other reproductive harm. For more information visit www.P65WARNINGS.ca.gov

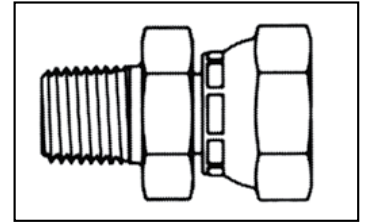

1404

PART NUMBER	UPC	DESCRIPTION
1405-6-6	746041054526	3/8" FEM PIPE x 3/8" FEM PIPE SWIVEL
1405-8-6	746041056636	1/2" FEM PIPE x 3/8" FEM PIPE SWIVEL
1405-8-8	746041054533	1/2" FEM PIPE x 1/2" FEM PIPE SWIVEL



WARNING: This product can expose you to chemicals including lead, which is known to the State of California to cause cancer or birth defects or other reproductive harm. For more information visit www.P65WARNINGS.ca.gov

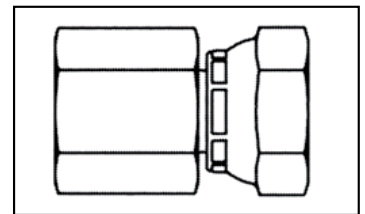

1405

PART NUMBER	UPC	DESCRIPTION
1406-6-6	746041054540	3/8" FEM PIPE SWIVEL x 3/8" FEM PIPE SWIVEL
1406-8-8	746041054557	1/2" FEM PIPE SWIVEL x 1/2" FEM PIPE SWIVEL



WARNING: This product can expose you to chemicals including lead, which is known to the State of California to cause cancer or birth defects or other reproductive harm. For more information visit www.P65WARNINGS.ca.gov

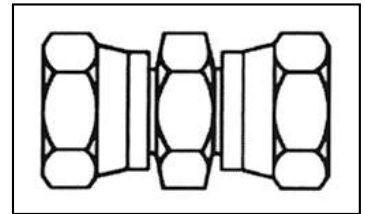

1406

PART NUMBER	UPC	DESCRIPTION
1501-4-4	746041055370	1/4" ML PIPE x 1/4" FEM PIPE SWIVEL, 90°
1501-4-6	746041064136	1/4" ML PIPE x 3/8" FEM PIPE SWIVEL, 90°
1501-6-6	746041054571	3/8" ML PIPE x 3/8" FEM PIPE SWIVEL, 90°
1501-6-8	746041055387	3/8" ML PIPE x 1/2" FEM PIPE SWIVEL, 90°
1501-8-6	746041055394	1/2" ML PIPE x 3/8" FEM PIPE SWIVEL, 90°
1501-8-8	746041054588	1/2" ML PIPE x 1/2" FEM PIPE SWIVEL, 90°



WARNING: This product can expose you to chemicals including lead, which is known to the State of California to cause cancer or birth defects or other reproductive harm. For more information visit www.P65WARNINGS.ca.gov

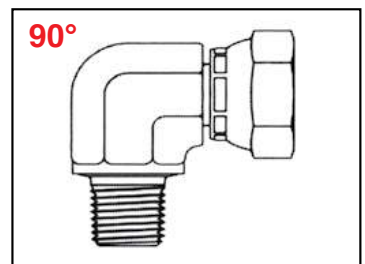

1501

PART NUMBER	UPC	DESCRIPTION
1502-4-4	746041063825	1/4" FEM PIPE x 1/4" FEM PIPE SWIVEL, 90°
1502-6-6	746041054595	3/8" FEM PIPE x 3/8" FEM PIPE SWIVEL, 90°
1502-8-8	746041054601	1/2" FEM PIPE x 1/2" FEM PIPE SWIVEL, 90°



WARNING: This product can expose you to chemicals including lead, which is known to the State of California to cause cancer or birth defects or other reproductive harm. For more information visit www.P65WARNINGS.ca.gov

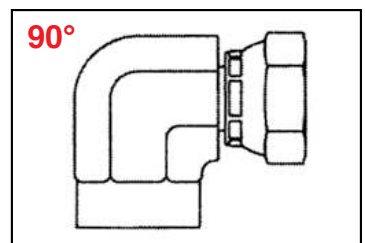

1502

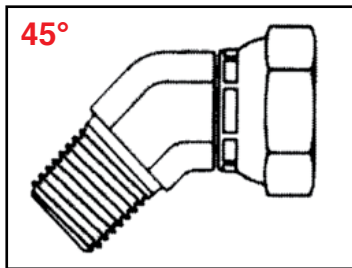

1503

PART NUMBER	UPC	DESCRIPTION
1503-6-6	746041054618	3/8" ML PIPE x 3/8" FEM PIPE SWIVEL, 45°
1503-6-8	746041064143	3/8" ML PIPE x 1/2" FEM PIPE SWIVEL, 45°
1503-8-8	746041054625	1/2" ML PIPE x 1/2" FEM PIPE SWIVEL, 45°

WARNING: This product can expose you to chemicals including lead, which is known to the State of California to cause cancer or birth defects or other reproductive harm. For more information visit www.P65WARNINGS.ca.gov

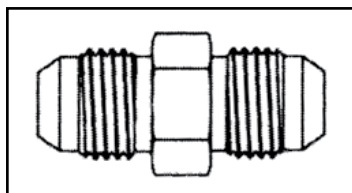

2403

PART NUMBER	UPC	DESCRIPTION
2403-6-6	746041064150	3/8" ML JIC x 3/8" ML JIC
2403-8-8	746041056865	1/2" ML JIC x 1/2" ML JIC
2403-12-12	746041064167	3/4" ML JIC x 3/4" ML JIC

WARNING: This product can expose you to chemicals including lead, which is known to the State of California to cause cancer or birth defects or other reproductive harm. For more information visit www.P65WARNINGS.ca.gov

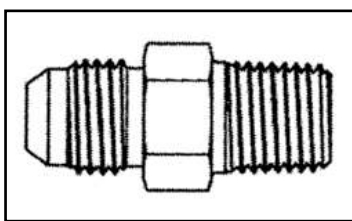

2404

PART NUMBER	UPC	DESCRIPTION
2404-4-4	746041064174	1/4" ML JIC x 1/4" ML PIPE
2404-6-6	746041055417	3/8" ML JIC x 3/8" ML PIPE
2404-8-6	746041056681	1/2" ML JIC x 3/8" ML PIPE
2404-8-8	746041056698	1/2" ML JIC x 1/2" ML PIPE
2404-10-8	746041055424	5/8" ML JIC x 1/2" ML PIPE
2404-12-12	746041056704	3/4" ML JIC x 3/4" ML PIPE

WARNING: This product can expose you to chemicals including lead, which is known to the State of California to cause cancer or birth defects or other reproductive harm. For more information visit www.P65WARNINGS.ca.gov

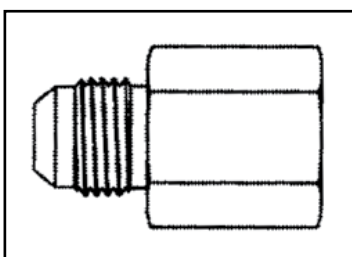

2405

PART NUMBER	UPC	DESCRIPTION
2405-6-6	746041056476	3/8" ML JIC x 3/8" FEM PIPE
2405-6-8	746041064181	3/8" ML JIC x 1/2" FEM PIPE
2405-8-6	746041054632	1/2" ML JIC x 3/8" FEM PIPE
2405-8-8	746041056483	1/2" ML JIC x 1/2" FEM PIPE
2405-10-8	746041054649	5/8" ML JIC x 1/2" FEM PIPE
2405-12-8	746041064198	3/4" ML JIC x 1/2" FEM PIPE

WARNING: This product can expose you to chemicals including lead, which is known to the State of California to cause cancer or birth defects or other reproductive harm. For more information visit www.P65WARNINGS.ca.gov

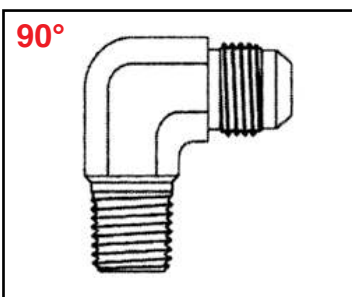

2501

PART NUMBER	UPC	DESCRIPTION
2501-4-4	746041064204	1/4" ML JIC x 1/4" ML PIPE RIGID, 90°
2501-4-6	746041064211	1/4" ML JIC x 3/8" ML PIPE RIGID, 90°
2501-6-6	746041056902	3/8" ML JIC x 3/8" ML PIPE RIGID, 90°
2501-6-8	746041056919	3/8" ML JIC x 1/2" ML PIPE RIGID, 90°
2501-8-6	746041064228	1/2" ML JIC x 3/8" ML PIPE RIGID, 90°
2501-8-8	746041056926	1/2" ML JIC x 1/2" ML PIPE RIGID, 90°

WARNING: This product can expose you to chemicals including lead, which is known to the State of California to cause cancer or birth defects or other reproductive harm. For more information visit www.P65WARNINGS.ca.gov

PART NUMBER	UPC	DESCRIPTION
5406-4-2	746041064235	1/4" ML PIPE x 1/8" FEM PIPE REDUCER
5406-6-4	746041054656	3/8" ML PIPE x 1/4" FEM PIPE REDUCER
5406-8-4	746041064242	1/2" ML PIPE x 1/4" FEM PIPE REDUCER
5406-8-6	746041056872	1/2" ML PIPE x 3/8" FEM PIPE REDUCER
5406-12-8	746041056889	3/4" ML PIPE x 1/2" FEM PIPE REDUCER

WARNING: This product can expose you to chemicals including lead, which is known to the State of California to cause cancer or birth defects or other reproductive harm. For more information visit www.P65WARNINGS.ca.gov

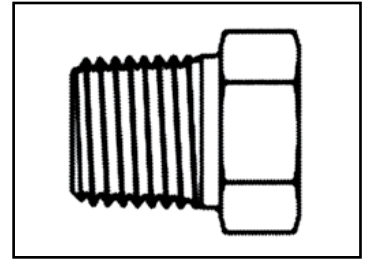

5406

PART NUMBER	UPC	DESCRIPTION
5504-4-4	746041064433	1/4" FEM PIPE x 1/4" FEM PIPE, 90°
5504-6-4	746041064440	3/8" FEM PIPE x 1/4" FEM PIPE, 90°
5504-6-6	746041064457	3/8" FEM PIPE x 3/8" FEM PIPE, 90°

WARNING: This product can expose you to chemicals including lead, which is known to the State of California to cause cancer or birth defects or other reproductive harm. For more information visit www.P65WARNINGS.ca.gov

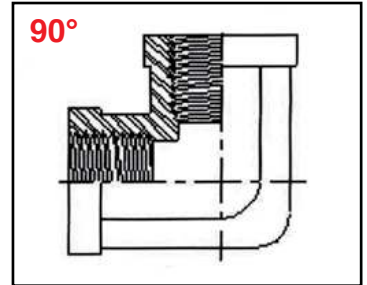

5504

PART NUMBER	UPC	DESCRIPTION
5605-4	746041064464	1/4" FEM PIPE TEE
5605-6	746041064471	3/8" FEM PIPE TEE

WARNING: This product can expose you to chemicals including lead, which is known to the State of California to cause cancer or birth defects or other reproductive harm. For more information visit www.P65WARNINGS.ca.gov

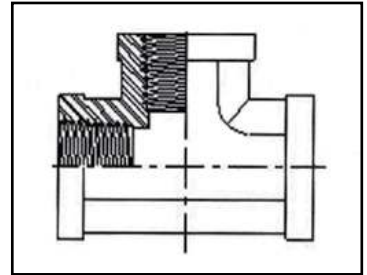

5605

PART NUMBER	UPC	DESCRIPTION
6401-6-6	746041064259	3/8" ML O-RING x 3/8" ML PIPE
6401-8-8	746041056858	1/2" ML O-RING x 1/2" ML PIPE
6401-10-8	746041064266	5/8" ML O-RING x 1/2" ML PIPE

WARNING: This product can expose you to chemicals including lead, which is known to the State of California to cause cancer or birth defects or other reproductive harm. For more information visit www.P65WARNINGS.ca.gov

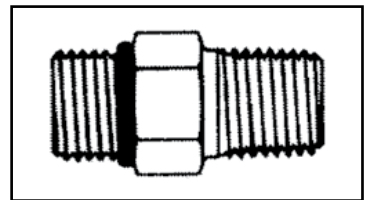

6401

PART NUMBER	UPC	DESCRIPTION
6404-6-6	746041056513	3/8" FEM O-RING x 3/8" ML PIPE
6404-8-8	746041054663	1/2" FEM O-RING x 1/2" ML PIPE
6404-10-8	746041056537	5/8" FEM O-RING x 1/2" ML PIPE

WARNING: This product can expose you to chemicals including lead, which is known to the State of California to cause cancer or birth defects or other reproductive harm. For more information visit www.P65WARNINGS.ca.gov

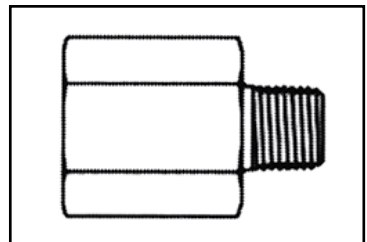

6404

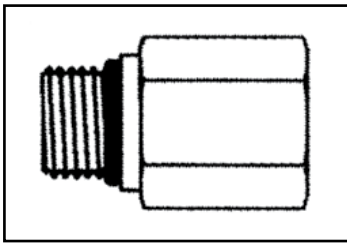

6405

PART NUMBER	UPC	DESCRIPTION
6405-6-6	746041064273	3/8" ML O-RING x 3/8" FEM PIPE
6405-6-8	746041064280	3/8" ML O-RING x 1/2" FEM PIPE
6405-8-6	746041054670	1/2" ML O-RING x 3/8" FEM PIPE
6405-8-8	746041054687	1/2" ML O-RING x 1/2" FEM PIPE
6405-10-8	746041054694	5/8" ML O-RING x 1/2" FEM PIPE
6405-12-12	746041064297	3/4" ML O-RING x 3/4" FEM PIPE

WARNING: This product can expose you to chemicals including lead, which is known to the State of California to cause cancer or birth defects or other reproductive harm. For more information visit www.P65WARNINGS.ca.gov

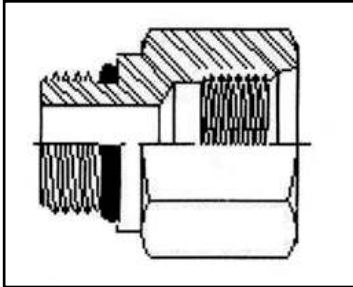

6410

PART NUMBER	UPC	DESCRIPTION
6410-8-6	746041056599	1/2" ML O-RING x 3/8" FEM O-RING
6410-8-10	746041056612	1/2" ML O-RING x 5/8" FEM O-RING
6410-10-8	746041056629	5/8" ML O-RING x 1/2" FEM O-RING

WARNING: This product can expose you to chemicals including lead, which is known to the State of California to cause cancer or birth defects or other reproductive harm. For more information visit www.P65WARNINGS.ca.gov

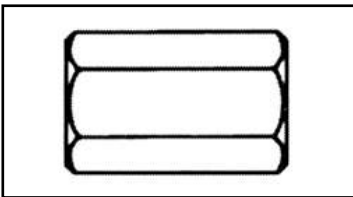

6420

PART NUMBER	UPC	DESCRIPTION
6420-6-8	746041064303	3/8" FEM O-RING x 1/2" FEM PIPE
6420-8-8	746041054700	1/2" FEM O-RING x 1/2" FEM PIPE
6420-8-10	746041064310	1/2" FEM O-RING x 5/8" FEM PIPE

WARNING: This product can expose you to chemicals including lead, which is known to the State of California to cause cancer or birth defects or other reproductive harm. For more information visit www.P65WARNINGS.ca.gov

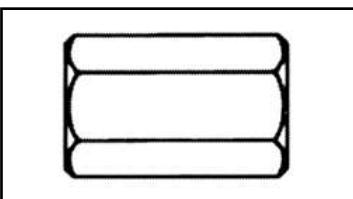

6425

PART NUMBER	UPC	DESCRIPTION
6425-4-4	746041064389	1/4" FEM O-RING x 1/4" FEM O-RING
6425-6-6	746041064396	3/8" FEM O-RING x 3/8" FEM O-RING
6425-8-6	746041064402	1/2" FEM O-RING x 3/8" FEM O-RING
6425-8-8	746041054717	1/2" FEM O-RING x 1/2" FEM O-RING
6425-12-8	746041064419	3/4" FEM O-RING x 1/2" FEM O-RING
6425-12-12	746041064426	3/4" FEM O-RING x 3/4" FEM O-RING

WARNING: This product can expose you to chemicals including lead, which is known to the State of California to cause cancer or birth defects or other reproductive harm. For more information visit www.P65WARNINGS.ca.gov

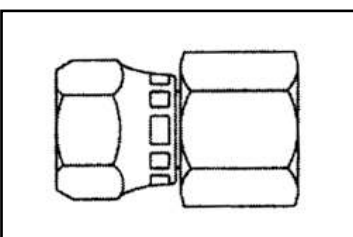

6506

PART NUMBER	UPC	DESCRIPTION
6506-6-6	746041054724	3/8" FEM PIPE x 3/8" FEM JIC SWIVEL
6506-6-8	746041054731	3/8" FEM PIPE x 1/2" FEM JIC SWIVEL
6506-8-6	746041382209	1/2" FEM PIPE x 3/8" FEM JIC SWIVEL
6506-8-8	746041054748	1/2" FEM PIPE x 1/2" FEM JIC SWIVEL
6506-8-10	746041064372	1/2" FEM PIPE x 5/8" FEM JIC SWIVEL
6506-10-8	746041056667	5/8" FEM PIPE x 1/2" FEM JIC SWIVEL

WARNING: This product can expose you to chemicals including lead, which is known to the State of California to cause cancer or birth defects or other reproductive harm. For more information visit www.P65WARNINGS.ca.gov

PART NUMBER	UPC	DESCRIPTION
6900-6-6	746041056582	3/8" ML O-RING x 3/8" FEM PIPE SWIVEL
6900-6-8	746041064327	3/8" ML O-RING x 1/2" FEM PIPE SWIVEL
6900-8-6	746041054779	1/2" ML O-RING x 3/8" FEM PIPE SWIVEL
6900-8-8	746041054786	1/2" ML O-RING x 1/2" FEM PIPE SWIVEL
6900-8-12	746041064334	1/2" ML O-RING x 3/4" FEM PIPE SWIVEL
6900-10-8	746041054793	5/8" ML O-RING x 1/2" FEM PIPE SWIVEL
6900-12-12	746041064341	3/4" ML O-RING x 3/4" FEM PIPE SWIVEL

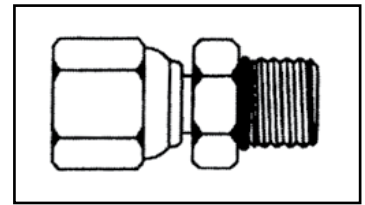

6900

! **WARNING:** This product can expose you to chemicals including lead, which is known to the State of California to cause cancer or birth defects or other reproductive harm. For more information visit www.P65WARNINGS.ca.gov

PART NUMBER	UPC	DESCRIPTION
6901-6-6	746041055431	3/8" ML O-RING x 3/8" FEM PIPE SWIVEL, 90°
6901-8-6	746041054809	1/2" ML O-RING x 3/8" FEM PIPE SWIVEL, 90°
6901-8-8	746041054816	1/2" ML O-RING x 1/2" FEM PIPE SWIVEL, 90°

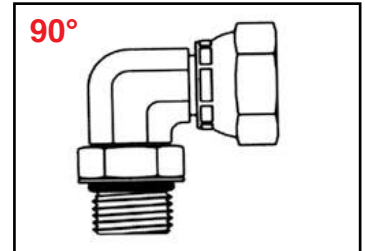

6901

! **WARNING:** This product can expose you to chemicals including lead, which is known to the State of California to cause cancer or birth defects or other reproductive harm. For more information visit www.P65WARNINGS.ca.gov

PART NUMBER	UPC	DESCRIPTION
6902-4-4	746041064358	1/4" ML O-RING x 1/4" FEM PIPE SWIVEL, 45°
6902-6-6	746041064365	3/8" ML O-RING x 3/8" FEM PIPE SWIVEL, 45°
6902-8-8	746041056742	1/2" ML O-RING x 1/2" FEM PIPE SWIVEL, 45°

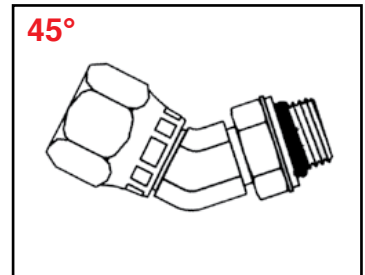

6902

! **WARNING:** This product can expose you to chemicals including lead, which is known to the State of California to cause cancer or birth defects or other reproductive harm. For more information visit www.P65WARNINGS.ca.gov



BLUE LAYFLAT BULK PVC WATER DISCHARGE HOSE



TUBE & COVER: Blue PVC

REINFORCEMENT: Polyester yarn

BRANDING: Jason logo WP XX (PSI) ID

TEMPERATURE RANGE: -14°F (-26°C) to +150°F (+66°C)

FEATURES: Light and easy to handle; rolls flat for storage. Homogeneous construction eliminates tube and cover separation. Reinforced with polyester yarn, both tube and cover are extruded simultaneously to achieve maximum bonding.

APPLICATION: For general purpose water discharge in construction, agriculture and drip irrigation.

PART NUMBER	UPC	WP	DESCRIPTION
4502-1500-025	746041064617	85	1-1/2" x 25' BLUE PVC DISCHARGE HOSE
4502-1500-050	746041022105	85	1-1/2" x 50' BLUE PVC DISCHARGE HOSE
4502-1500-100	746041465278	85	1-1/2" x 100' BLUE PVC DISCHARGE HOSE
4502-1500	746041022532	85	1-1/2" x 300' BLUE PVC DISCHARGE HOSE
4502-2000-050	746041022051	85	2" x 50' BLUE PVC DISCHARGE HOSE
4502-2000-100	746041465285	85	2" x 100' BLUE PVC DISCHARGE HOSE
4502-2000	746041021078	85	2" x 300' BLUE PVC DISCHARGE HOSE
4502-2500	746041327958	75	2-1/2" x 300' BLUE PVC DISCHARGE HOSE
4502-3000-050	746041022617	70	3" x 50' BLUE PVC DISCHARGE HOSE
4502-3000-100	746041465292	70	3" x 100' BLUE PVC DISCHARGE HOSE
4502-3000	746041055073	70	3" x 300' BLUE PVC DISCHARGE HOSE

25' & 50' cut sections are shrink-wrapped and bar-coded.



WARNING: This product can expose you to chemicals including DINP, which is known to the State of California to cause cancer or birth defects or other reproductive harm. For more information visit www.P65WARNINGS.ca.gov

PIN LUG COUPLED DISCHARGE HOSE

Short Shank - Male/Female, Aluminum/Brass



PART NUMBER	UPC	DESCRIPTION
4502-1500-025AB	746041055080	1-1/2" x 25' BLUE MxF ALUM/BRASS, PIN LUG
4502-1500-050AB	746041055110	1-1/2" x 50' BLUE MxF ALUM/BRASS, PIN LUG
4502-2000-025AB	746041055097	2" x 25' BLUE MxF ALUM/BRASS, PIN LUG
4502-2000-050AB	746041055127	2" x 50' BLUE MxF ALUM/BRASS, PIN LUG
4502-3000-025AB	746041055103	3" x 25' BLUE MxF ALUM/BRASS, PIN LUG
4502-3000-050AB	746041055134	3" x 50' BLUE MxF ALUM/BRASS, PIN LUG



WARNING: This product can expose you to chemicals including DINP, which is known to the State of California to cause cancer or birth defects or other reproductive harm. For more information visit www.P65WARNINGS.ca.gov

CAM & GROOVE COUPLED DISCHARGE HOSE

CxE Polypropylene - "C" Female Coupler & "E" Male Adapter



PART NUMBER	UPC	DESCRIPTION
4502-1500-025CEP	746041055141	1-1/2" x 25' BLUE CxE CPLD, POLYPROPYLENE
4502-1500-050CEP	746041055172	1-1/2" x 50' BLUE CxE CPLD, POLYPROPYLENE
4502-2000-025CEP	746041055158	2" x 25' BLUE CxE CPLD, POLYPROPYLENE
4502-2000-050CEP	746041055189	2" x 50' BLUE CxE CPLD, POLYPROPYLENE
4502-3000-025CEP	746041055165	3" x 25' BLUE CxE CPLD, POLYPROPYLENE
4502-3000-050CEP	746041055196	3" x 50' BLUE CxE CPLD, POLYPROPYLENE



WARNING: This product can expose you to chemicals including DINP, which is known to the State of California to cause cancer or birth defects or other reproductive harm. For more information visit www.P65WARNINGS.ca.gov

RED PVC BULK WATER DISCHARGE HOSE

TUBE & COVER: Wine Red PVC

REINFORCEMENT: Polyester yarn

BRANDING: Jason logo ID WP XX (PSI)

TEMPERATURE RANGE: -14°F (-26°C) to +150°F (+66°C)

FEATURES: Medium duty hose; rolls flat for storage. Homogeneous construction eliminates tube and cover separation. Reinforced with polyester yarn, both tube and cover are extruded simultaneously to achieve maximum bonding.

APPLICATION: For general purpose water discharge in construction, agriculture and drip irrigation.



PART NUMBER	UPC	WP	DESCRIPTION
4504-1500	746041328009	115	1-1/2" x 300' RED PVC DISCHARGE HOSE
4504-2000	746041328016	115	2" x 300' RED PVC DISCHARGE HOSE
4504-2500	746041328047	115	2-1/2" x 300' RED PVC DISCHARGE HOSE
4504-3000	746041328054	100	3" x 300' RED PVC DISCHARGE HOSE

WARNING: This product can expose you to chemicals including DINP, which is known to the State of California to cause cancer or birth defects or other reproductive harm. For more information visit www.P65WARNINGS.ca.gov

PIN LUG COUPLED DISCHARGE HOSE

Short Shank - Male/Female, Aluminum/Brass

PART NUMBER	UPC	DESCRIPTION
4504-2000-050AB	746041328023	2" x 50' PVC RED, ALUM/BRASS, PIN LUG
4504-3000-050AB	746041328061	3" x 50' PVC RED, ALUM/BRASS, PIN LUG

WARNING: This product can expose you to chemicals including DINP, which is known to the State of California to cause cancer or birth defects or other reproductive harm. For more information visit www.P65WARNINGS.ca.gov



CAM & GROOVE COUPLED DISCHARGE HOSE

CxE Aluminum

PART NUMBER	UPC	DESCRIPTION
4504-2000-050CE	746041328030	2" x 50' PVC RED, CxE COUPLED, ALUMINUM
4504-3000-050CE	746041328078	3" x 50' PVC RED, CxE COUPLED, ALUMINUM

WARNING: This product can expose you to chemicals including DINP, which is known to the State of California to cause cancer or birth defects or other reproductive harm. For more information visit www.P65WARNINGS.ca.gov



HEAVY DUTY BULK DISCHARGE HOSE

PART NUMBER	UPC	WP	DESCRIPTION
4515-1500	746041328115	140	1-1/2" x 300' HD PVC DISCHARGE HOSE
4515-2000	746041328122	130	2" x 300' HD PVC DISCHARGE HOSE
4515-2500	746041328139	125	2-1/2" x 300' HD PVC DISCHARGE HOSE
4515-3000	746041328146	125	3" x 300' HD PVC DISCHARGE HOSE

WARNING: This product can expose you to chemicals including DINP, which is known to the State of California to cause cancer or birth defects or other reproductive harm. For more information visit www.P65WARNINGS.ca.gov



WHITE MUNICIPAL GRADE SINGLE JACKET MILL HOSE



BULK

TUBE: SBR, smooth

REINFORCEMENT: N/A

COVER: 100% polyester single jacket

BRANDING: I.D. SJ Mill WP XX (PSI) XX (BAR)

TEMPERATURE RANGE: -25°F (-32°C) to +185°F (+85°C)

FEATURES: Heavy-duty synthetic cover for better abrasion resistance and abuse. Higher working pressures.

APPLICATION: For water discharge service in rental yards, fleet service, municipal washdown, utility dewatering.

PART NUMBER	UPC	WP	DESCRIPTION
4705-0150-050	746041059842	230	1-1/2" x 50' WHITE DISCHARGE HOSE
4705-0150-100	746041059859	230	1-1/2" x 100' WHITE DISCHARGE HOSE
4705-0200-050	746041059866	230	2" x 50' WHITE DISCHARGE HOSE
4705-0200-100	746041059873	230	2" x 100' WHITE DISCHARGE HOSE
4705-0250-050	746041059880	200	2-1/2" x 50' WHITE DISCHARGE HOSE
4705-0250-100	746041059897	200	2-1/2" x 100' WHITE DISCHARGE HOSE
4705-0300-050	746041059903	200	3" x 50' WHITE DISCHARGE HOSE
4705-0300-100	746041059910	200	3" x 100' WHITE DISCHARGE HOSE
4705-0400-050	746041327545	200	4" x 50' WHITE DISCHARGE HOSE
4705-0400-100	746041327552	200	4" x 100' WHITE DISCHARGE HOSE
4705-0600-050	746041327569	200	6" x 50' WHITE DISCHARGE HOSE

WARNING: This product can expose you to chemicals including carbon black, which is known to the State of California to cause cancer or birth defects or other reproductive harm. For more information visit www.P65WARNINGS.ca.gov

PIN LUG COUPLED SINGLE JACKET MILL HOSE



Short Shank - Male/Female, Aluminum/Brass

PART NUMBER	UPC	DESCRIPTION
4705-0150-050AB	746041327422	1-1/2" x 50' WHITE ALUM/BRASS, PIN LUG, 3/8 BANDS
4705-0200-050AB	746041327460	2" x 50' WHITE ALUM/BRASS, PIN LUG, 5/8 BANDS
4705-0300-050AB	746041327521	3" x 50' WHITE ALUM/BRASS, PIN LUG, 3/4 BANDS

WARNING: This product can expose you to chemicals including carbon black, which is known to the State of California to cause cancer or birth defects or other reproductive harm. For more information visit www.P65WARNINGS.ca.gov

CAM & GROOVE COUPLED SINGLE JACKET MILL HOSE



CxE Aluminum

PART NUMBER	UPC	DESCRIPTION
4705-0150-050CE	746041327439	1-1/2" x 50' WHITE CxE COUPLED, 3/8 BANDS
4705-0200-050CE	746041327477	2" x 50' WHITE CxE COUPLED, 5/8 BANDS
4705-0300-050CE	746041327538	3" x 50' WHITE CxE COUPLED, 3/4 BANDS

WARNING: This product can expose you to chemicals including carbon black, which is known to the State of California to cause cancer or birth defects or other reproductive harm. For more information visit www.P65WARNINGS.ca.gov

GREEN PVC BULK WATER SUCTION HOSE

TUBE: PVC, smooth, green

REINFORCEMENT: PVC helix

COVER: PVC, smooth to lightly corrugated, green

BRANDING: None

TEMPERATURE RANGE: -14°F (-26°C) to +150°F (+66°C)

FEATURES: Lightweight and flexible with a smooth tube. Cover is weather, ozone and UV resistant.

APPLICATION: Suction, discharge or gravity flow of water, salt water and oily water in construction, agriculture, mining or equipment rental.



PART NUMBER	UPC	DESCRIPTION
4601-1000	746041055622	1" x 100' GREEN SUCTION HOSE
4601-1250	746041021504	1-1/4" x 100' GREEN SUCTION HOSE
4601-1500-010	746041065133	1-1/2" x 10' GREEN SUCTION HOSE
4601-1500-025	746041064655	1-1/2" x 25' GREEN SUCTION HOSE
4601-1500-050	746041064648	1-1/2" x 50' GREEN SUCTION HOSE
4601-1500	746041021511	1-1/2" x 100' GREEN SUCTION HOSE
4601-2000-010	746041065140	2" x 10' GREEN SUCTION HOSE
4601-2000-025	746041064662	2" x 25' GREEN SUCTION HOSE
4601-2000-050	746041064679	2" x 50' GREEN SUCTION HOSE
4601-2000	746041021528	2" x 100' GREEN SUCTION HOSE
4601-3000-010	746041065119	3" x 10' GREEN SUCTION HOSE
4601-3000-025	746041064686	3" x 25' GREEN SUCTION HOSE
4601-3000-050	746041064693	3" x 50' GREEN SUCTION HOSE
4601-3000	746041055639	3" x 100' GREEN SUCTION HOSE

WARNING: This product can expose you to chemicals including DINP, which is known to the State of California to cause cancer or birth defects or other reproductive harm. For more information visit www.P65WARNINGS.ca.gov

PIN LUG COUPLED GREEN PVC SUCTION HOSE

Short Shank - Male/Female, Aluminum/Brass

PART NUMBER	UPC	DESCRIPTION
4601-15015AB	746041428891	1-1/2" x 15' GREEN MxF ALUM/BRASS, PIN LUG
4601-15020AB	746041062453	1-1/2" x 20' GREEN MxF ALUM/BRASS, PIN LUG
4601-15025AB	746041063627	1-1/2" x 25' GREEN MxF ALUM/BRASS, PIN LUG
4601-20015AB	746041428914	2" x 15' GREEN MxF ALUM/BRASS, PIN LUG
4601-20020AB	746041022204	2" x 20' GREEN MxF ALUM/BRASS, PIN LUG
4601-20025AB	746041063634	2" x 25' GREEN MxF ALUM/BRASS, PIN LUG
4601-30015AB	746041062521	3" x 15' GREEN MxF ALUM/BRASS, PIN LUG
4601-30020AB	746041062460	3" x 20' GREEN MxF ALUM/BRASS, PIN LUG
4601-30025AB	746041063641	3" x 25' GREEN MxF ALUM/BRASS, PIN LUG



WARNING: This product can expose you to chemicals including DINP, which is known to the State of California to cause cancer or birth defects or other reproductive harm. For more information visit www.P65WARNINGS.ca.gov

CAM & GROOVE COUPLED GREEN PVC SUCTION HOSE

CxE Polypropylene

PART NUMBER	UPC	DESCRIPTION
4601-15015CEP	746041428907	1-1/2" x 15' GREEN CxE CPLD, POLYPROPYLENE
4601-15020CEP	746041063658	1-1/2" x 20' GREEN CxE CPLD, POLYPROPYLENE
4601-15025CEP	746041063665	1-1/2" x 25' GREEN CxE CPLD, POLYPROPYLENE
4601-20015CEP	746041415426	2" x 15' GREEN CxE CPLD, POLYPROPYLENE
4601-20020CEP	746041063306	2" x 20' GREEN CxE CPLD, POLYPROPYLENE
4601-20025CEP	746041063672	2" x 25' GREEN CxE CPLD, POLYPROPYLENE
4601-30015CEP	746041428921	3" x 15' GREEN CxE CPLD, POLYPROPYLENE
4601-30020CEP	746041063689	3" x 20' GREEN CxE CPLD, POLYPROPYLENE
4601-30025CEP	746041063696	3" x 25' GREEN CxE CPLD, POLYPROPYLENE



WARNING: This product can expose you to chemicals including DINP, which is known to the State of California to cause cancer or birth defects or other reproductive harm. For more information visit www.P65WARNINGS.ca.gov

CLEAR/WHITE HELIX PVC WATER SUCTION HOSE



TUBE: PVC, smooth, clear

REINFORCEMENT: PVC helix

COVER: PVC, smooth to lightly corrugated, clear

BRANDING: None

TEMPERATURE RANGE: -14°F (-26°C) to +150°F (+66°C)

FEATURES: Lightweight and flexible with a smooth tube. Clear tube allows easy inspection. Cover is weather, ozone and UV resistant.

APPLICATION: Suction, discharge or gravity flow of water, salt water and oily water in construction, agriculture, mining or equipment rental.

PART NUMBER	UPC	DESCRIPTION
4615-0750	746041059477	3/4" x 100' WHITE HELIX SUCTION HOSE
4615-1000	746041055646	1" x 100' WHITE HELIX SUCTION HOSE
4615-1250	746041055653	1-1/4" x 100' WHITE HELIX SUCTION HOSE
4615-1500	746041055660	1-1/2" x 100' WHITE HELIX SUCTION HOSE
4615-2000	746041055677	2" x 100' WHITE HELIX SUCTION HOSE
4615-3000	746041055684	3" x 100' WHITE HELIX SUCTION HOSE

 **WARNING:** This product can expose you to chemicals including DINP, which is known to the State of California to cause cancer or birth defects or other reproductive harm. For more information visit www.P65WARNINGS.ca.gov

HD PVC FDA USDA 3-A LIQUID FOOD SUCTION HOSE



CONSTRUCTION: PVC tube with a sturdy clockwise PVC helix.

TEMPERATURE RANGE: -5°F (-23°C) to +140°F (+60°C)

STANDARD LENGTHS: 100 ft. lengths

APPLICATION: Transfer of food grade liquids, such as juices, wine, beer, potable water and dairy products.

FEATURES:

- Meets FDA requirements.
- Approved by USDA for use in meat and poultry plants.
- Meets 3-A sanitary standards, which includes processing dairy products.
- Clear visual flow.
- Vacuum up to 29" of Hg.

Part Number	I.D.		O.D.		Rein.	Max W.P. @68°F		Vacuum @68°F	Weight		Min. Bend Radius	
	In.	mm.	In.	mm.		PSI	BAR		lb./ft.	KG/m	In.	mm.
3010-0100-100	1	25.40	1.24	31.50	PVC Helix	71	4.90	29.9	0.26	0.39	3.0	76.2
3010-0125-100	1-1/4	31.75	1.54	39.12	PVC Helix	64	4.41	29.9	0.34	0.51	4.0	101.6
3010-0150-100	1-1/2	38.10	1.82	46.23	PVC Helix	57	3.93	29.9	0.44	0.65	6.0	152.4
3010-0200-100	2	50.80	2.39	60.71	PVC Helix	57	3.93	29.9	0.74	1.10	8.0	203.2
3010-0250-100	2-1/2	63.50	2.93	74.42	PVC Helix	57	3.93	29.9	1.01	1.50	10.0	254.0
3010-0300-100	3	76.20	3.43	87.12	PVC Helix	57	3.93	29.9	1.21	1.80	12.0	304.8
3010-0400-100	4	101.60	4.53	115.06	PVC Helix	43	2.97	29.9	2.02	3.01	15.0	381.0

Note: Vacuum and discharge pressures are temperature dependent.

 **WARNING:** This product can expose you to chemicals including DINP, which is known to the State of California to cause cancer or birth defects or other reproductive harm. For more information visit www.P65WARNINGS.ca.gov

GREEN/BLACK AGRICULTURE SOLUTION SUCTION HOSE - BULK

BRANDING: None

TEMPERATURE RANGE: -40°F (-40°C) to +140°F (+60°C)

FEATURES: NBR rubber with polyethylene helix characterizing a smooth tube and corrugated cover.

APPLICATION: For suction or discharge in cesspool cleaning, liquid waste, septic handling, construction and marine use. Ideal herbicide and pesticide transfer hose for agriculture.
DO NOT USE WITH ANHYDROUS AMMONIA.



Part Number	UPC	I.D.	O.D.	WP	BEND RADIUS (IN)	DESCRIPTION
4654-0100-010	746041065102	1	1.34	50	1.9	1" x 10' NBR/PVC GRN/BLK SUCTION HOSE
4654-0100-025	746041064709	1	1.34	50	1.9	1" x 25' NBR/PVC GRN/BLK SUCTION HOSE
4654-0100-050	746041064754	1	1.34	50	1.9	1" x 50' NBR/PVC GRN/BLK SUCTION HOSE
4654-0100-100	746041062019	1	1.34	50	1.9	1" x 100' NBR/PVC GRN/BLK SUCTION HOSE
4654-0150-010	746041065188	1-1/2	1.85	50	3.8	1-1/2" x 10' NBR/PVC GRN/BLK SUCTION HOSE
4654-0150-025	746041064785	1-1/2	1.85	50	3.8	1-1/2" x 25' NBR/PVC GRN/BLK SUCTION HOSE
4654-0150-050	746041064792	1-1/2	1.85	50	3.8	1-1/2" x 50' NBR/PVC GRN/BLK SUCTION HOSE
4654-0150-100	746041062002	1-1/2	1.85	50	3.8	1-1/2" x 100' NBR/PVC GRN/BLK SUCTION HOSE
4654-0200-010	746041065171	2	2.43	50	5.5	2" x 10' NBR/PVC GRN/BLK SUCTION HOSE
4654-0200-025	746041064808	2	2.43	50	5.5	2" x 25' NBR/PVC GRN/BLK SUCTION HOSE
4654-0200-050	746041064761	2	2.43	50	5.5	2" x 50' NBR/PVC GRN/BLK SUCTION HOSE
4654-0200-100	746041057480	2	2.43	50	5.5	2" x 100' NBR/PVC GRN/BLK SUCTION HOSE
4654-0300-100	746041057497	3	3.52	45	7.5	3" x 100' NBR/PVC GRN/BLK SUCTION HOSE
4654-0400-100	746041428938	4	4.60	38	11.5	4" x 100' NBR/PVC GRN/BLK SUCTION HOSE

WARNING: This product can expose you to chemicals including carbon black, which is known to the State of California to cause cancer or birth defects or other reproductive harm. For more information visit www.P65WARNINGS.ca.gov

BLACK RUBBER SUCTION HOSE - BULK

TUBE: EPDM/SBR, smooth, black

REINFORCEMENT: Synthetic cord with wire helix

COVER: EPDM/SBR, weather and ozone resistant, fabric impression

BRANDING: Jason logo, 4450 Water S/D

TEMPERATURE RANGE: -25°F (-32°C) to +185°F (+85°C)

FEATURES: Resistant to water based AG fertilizers and salt water. Flexible and economical.

APPLICATION: Lightweight and flexible suction/discharge hose for agriculture, construction, mining and equipment rental. Hose is resistant to herbicides/pesticides. Outstanding flexibility in cold weather.



Part Number	UPC	I.D.	O.D.	WP	BEND RADIUS (IN)	DESCRIPTION
4450-0125-100	746041055691	1-1/4	1.70	150	6	1-1/4" x 100' EPDM/SBR SUCTION HOSE
4450-0150-100	746041055707	1-1/2	1.96	150	8	1-1/2" x 100' EPDM/SBR SUCTION HOSE
4450-0200-100	746041055714	2	2.49	150	12	2" x 100' EPDM/SBR SUCTION HOSE
4450-0300-100	746041055721	3	3.50	150	18	3" x 100' EPDM/SBR SUCTION HOSE

Additional diameters available upon request.

WARNING: This product can expose you to chemicals including carbon black, which is known to the State of California to cause cancer or birth defects or other reproductive harm. For more information visit www.P65WARNINGS.ca.gov

STRAINERS FOR WATER SUCTION HOSE, FOG NOZZLES

Used on the submersed end of suction hose to prevent debris from entering the pump during operation. All threads are NPS (trash strainers are square hole).



Polypropylene

PART NUMBER	UPC	DESCRIPTION
PS150	746041022563	1-1/2" POLYPROPYLENE STRAINER
PS200	746041022570	2" POLYPROPYLENE STRAINER

 **WARNING:** This product can expose you to chemicals including DINP, which is known to the State of California to cause cancer or birth defects or other reproductive harm. For more information visit www.P65WARNINGS.ca.gov



Round Hole

PART NUMBER	UPC	DESCRIPTION
RHS150	746041053253	1-1/2" ROUND HOLE STRAINER
RHS200	746041022556	2" ROUND HOLE STRAINER
RHS300	746041054854	3" ROUND HOLE STRAINER
RHS400	746041059743	4" ROUND HOLE STRAINER

 **WARNING:** This product can expose you to chemicals including lead, which is known to the State of California to cause cancer or birth defects or other reproductive harm. For more information visit www.P65WARNINGS.ca.gov



Square Hole

PART NUMBER	UPC	DESCRIPTION
SHS150	746041059736	1-1/2" SQUARE HOLE STRAINER
SHS200	746041022624	2" SQUARE HOLE STRAINER
SHS300	746041060091	3" SQUARE HOLE STRAINER
SHS400	746041060107	4" SQUARE HOLE STRAINER
SHS600	746041330194	6" SQUARE HOLE STRAINER

 **WARNING:** This product can expose you to chemicals including lead, which is known to the State of California to cause cancer or birth defects or other reproductive harm. For more information visit www.P65WARNINGS.ca.gov



Bottom Hole

PART NUMBER	UPC	DESCRIPTION
BHS150	746041059736	1-1/2" BOTTOM HOLE STRAINER
BHS200	746041022624	2" BOTTOM HOLE STRAINER
BHS300	746041060091	3" BOTTOM HOLE STRAINER

 **WARNING:** This product can expose you to chemicals including lead, which is known to the State of California to cause cancer or birth defects or other reproductive harm. For more information visit www.P65WARNINGS.ca.gov



Foot Valve

PART NUMBER	UPC	DESCRIPTION
FV150	746041333911	1-1/2" FOOT VALVE
FV200	746041333928	2" FOOT VALVE
FV300	746041059668	3" FOOT VALVE

 **WARNING:** This product can expose you to chemicals including lead, which is known to the State of California to cause cancer or birth defects or other reproductive harm. For more information visit www.P65WARNINGS.ca.gov



Fog Nozzle - Plastic

PART NUMBER	UPC	DESCRIPTION	THREAD
FN150	746041334352	1-1/2" FOG NOZZLE	NPS
FN200	746041485771	2" FOG NOZZLE	NPS

 **WARNING:** This product can expose you to chemicals including DINP, which is known to the State of California to cause cancer or birth defects or other reproductive harm. For more information visit www.P65WARNINGS.ca.gov

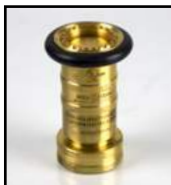

Fog Nozzle - Brass

PART NUMBER	UPC	DESCRIPTION	THREAD
FN150B	746041334369	1-1/2" FOG NOZZLE	NPS
FN200B	746041334390	2" FOG NOZZLE	NPS

 **WARNING:** This product can expose you to chemicals including lead, which is known to the State of California to cause cancer or birth defects or other reproductive harm. For more information visit www.P65WARNINGS.ca.gov

CAM & GROOVE COUPLINGS - A

ALUMINUM Adapter x Female NPT

PART NUMBER	UPC	DESCRIPTION
A075A	746041060114	3/4" A ALUM ADAPTER x FEM NPT
A100A	746041023287	1" A ALUM ADAPTER x FEM NPT
A125A	746041023584	1-1/4" A ALUM ADAPTER x FEM NPT
A150A	746041060121	1-1/2" A ALUM ADAPTER x FEM NPT
A200A	746041022846	2" A ALUM ADAPTER x FEM NPT
A300A	746041022709	3" A ALUM ADAPTER x FEM NPT

WARNING: This product can expose you to chemicals including lead, which is known to the State of California to cause cancer or birth defects or other reproductive harm. For more information visit www.P65WARNINGS.ca.gov



POLYPROPYLENE Adapter x Female NPT

PART NUMBER	UPC	DESCRIPTION
A050P	746041339609	1/2" A POLYPROPYLENE ADAPTER x FEM NPT
A075P	746041060282	3/4" A POLYPROPYLENE ADAPTER x FEM NPT
A100P	746041060299	1" A POLYPROPYLENE ADAPTER x FEM NPT
A125P	746041060305	1-1/4" A POLYPROPYLENE ADAPTER x FEM NPT
A150P	746041060312	1-1/2" A POLYPROPYLENE ADAPTER x FEM NPT
A200P	746041060329	2" A POLYPROPYLENE ADAPTER x FEM NPT
A300P	746041060336	3" A POLYPROPYLENE ADAPTER x FEM NPT

WARNING: This product can expose you to chemicals including DINP, which is known to the State of California to cause cancer or birth defects or other reproductive harm. For more information visit www.P65WARNINGS.ca.gov



CAM & GROOVE COUPLINGS - B

ALUMINUM Coupler x Male NPT

PART NUMBER	UPC	DESCRIPTION
B075A	746041060138	3/4" B ALUM COUPLER x ML NPT
B100A	746041023171	1" B ALUM COUPLER x ML NPT
B125A	746041060145	1-1/4" B ALUM COUPLER x ML NPT
B150A	746041060152	1-1/2" B ALUM COUPLER x ML NPT
B200A	746041022822	2" B ALUM COUPLER x ML NPT
B300A	746041022716	3" B ALUM COUPLER x ML NPT

WARNING: This product can expose you to chemicals including lead, which is known to the State of California to cause cancer or birth defects or other reproductive harm. For more information visit www.P65WARNINGS.ca.gov



POLYPROPYLENE Coupler x Male NPT

PART NUMBER	UPC	DESCRIPTION
B050P	746041342180	1/2" B POLYPROPYLENE COUPLER x ML NPT
B075P	746041060343	3/4" B POLYPROPYLENE COUPLER x ML NPT
B100P	746041060350	1" B POLYPROPYLENE COUPLER x ML NPT
B125P	746041060367	1-1/4" B POLYPROPYLENE COUPLER x ML NPT
B150P	746041060374	1-1/2" B POLYPROPYLENE COUPLER x ML NPT
B200P	746041060381	2" B POLYPROPYLENE COUPLER x ML NPT
B300P	746041060398	3" B POLYPROPYLENE COUPLER x ML NPT

WARNING: This product can expose you to chemicals including DINP, which is known to the State of California to cause cancer or birth defects or other reproductive harm. For more information visit www.P65WARNINGS.ca.gov



CAM & GROOVE COUPLINGS - C



ALUMINUM Coupler x Hose Shank

PART NUMBER	UPC	DESCRIPTION
C075A	746041060169	3/4" C ALUM COUPLER x SHANK
C100A	746041023188	1" C ALUM COUPLER x SHANK
C125A	746041060176	1-1/4" C ALUM COUPLER x SHANK
C150A	746041022679	1-1/2" C ALUM COUPLER x SHANK
C200A	746041022815	2" C ALUM COUPLER x SHANK
C300A	746041022723	3" C ALUM COUPLER x SHANK

WARNING: This product can expose you to chemicals including lead, which is known to the State of California to cause cancer or birth defects or other reproductive harm. For more information visit www.P65WARNINGS.ca.gov



POLYPROPYLENE Coupler x Hose Shank

PART NUMBER	UPC	DESCRIPTION
C050P	746041341442	1/2" C POLYPROPYLENE COUPLER x SHANK
C075P	746041060404	3/4" C POLYPROPYLENE COUPLER x SHANK
C100P	746041060411	1" C POLYPROPYLENE COUPLER x SHANK
C125P	746041060428	1-1/4" C POLYPROPYLENE COUPLER x SHANK
C150P	746041060435	1-1/2" C POLYPROPYLENE COUPLER x SHANK
C200P	746041060442	2" C POLYPROPYLENE COUPLER x SHANK
C300P	746041060459	3" C POLYPROPYLENE COUPLER x SHANK

WARNING: This product can expose you to chemicals including DINP, which is known to the State of California to cause cancer or birth defects or other reproductive harm. For more information visit www.P65WARNINGS.ca.gov

CAM & GROOVE COUPLINGS - D



ALUMINUM Coupler x Female NPT

PART NUMBER	UPC	DESCRIPTION
D075A	746041060183	3/4" D ALUM COUPLER x FEM NPT
D100A	746041023195	1" D ALUM COUPLER x FEM NPT
D125A	746041023201	1-1/4" D ALUM COUPLER x FEM NPT
D150A	746041052980	1-1/2" D ALUM COUPLER x FEM NPT
D200A	746041023423	2" D ALUM COUPLER x FEM NPT
D300A	746041022785	3" D ALUM COUPLER x FEM NPT

WARNING: This product can expose you to chemicals including lead, which is known to the State of California to cause cancer or birth defects or other reproductive harm. For more information visit www.P65WARNINGS.ca.gov



POLYPROPYLENE Coupler x Female NPT

PART NUMBER	UPC	DESCRIPTION
D050P	746041342197	1/2" D POLYPROPYLENE COUPLER x FEM NPT
D075P	746041060466	3/4" D POLYPROPYLENE COUPLER x FEM NPT
D100P	746041060473	1" D POLYPROPYLENE COUPLER x FEM NPT
D125P	746041060480	1-1/4" D POLYPROPYLENE COUPLER x FEM NPT
D150P	746041060497	1-1/2" D POLYPROPYLENE COUPLER x FEM NPT
D200P	746041060503	2" D POLYPROPYLENE COUPLER x FEM NPT
D300P	746041060510	3" D POLYPROPYLENE COUPLER x FEM NPT

WARNING: This product can expose you to chemicals including DINP, which is known to the State of California to cause cancer or birth defects or other reproductive harm. For more information visit www.P65WARNINGS.ca.gov

CAM & GROOVE COUPLINGS - E

ALUMINUM Adapter x Hose Shank

PART NUMBER	UPC	DESCRIPTION
E075A	746041060268	3/4" E ALUM ADAPTER x SHANK
E100A	746041023218	1" E ALUM ADAPTER x SHANK
E125A	746041023225	1-1/4" E ALUM ADAPTER x SHANK
E150A	746041022686	1-1/2" E ALUM ADAPTER x SHANK
E200A	746041022693	2" E ALUM ADAPTER x SHANK
E300A	746041022983	3" E ALUM ADAPTER x SHANK

WARNING: This product can expose you to chemicals including lead, which is known to the State of California to cause cancer or birth defects or other reproductive harm. For more information visit www.P65WARNINGS.ca.gov



POLYPROPYLENE Adapter x Hose Shank

PART NUMBER	UPC	DESCRIPTION
E050P	746041342210	1/2" E POLYPROPYLENE ADAPTER x SHANK
E075P	746041060633	3/4" E POLYPROPYLENE ADAPTER x SHANK
E100P	746041060640	1" E POLYPROPYLENE ADAPTER x SHANK
E125P	746041060657	1-1/4" E POLYPROPYLENE ADAPTER x SHANK
E150P	746041060664	1-1/2" E POLYPROPYLENE ADAPTER x SHANK
E200P	746041060671	2" E POLYPROPYLENE ADAPTER x SHANK
E300P	746041060688	3" E POLYPROPYLENE ADAPTER x SHANK

WARNING: This product can expose you to chemicals including DINP, which is known to the State of California to cause cancer or birth defects or other reproductive harm. For more information visit www.P65WARNINGS.ca.gov



CAM & GROOVE COUPLINGS - F

ALUMINUM Adapter x Male NPT

PART NUMBER	UPC	DESCRIPTION
F075A	746041060275	3/4" F ALUM ADAPTER x ML NPT
F100A	746041023232	1" F ALUM ADAPTER x ML NPT
F125A	746041054373	1-1/4" F ALUM ADAPTER x ML NPT
F150A	746041052997	1-1/2" F ALUM ADAPTER x ML NPT
F200A	746041022839	2" F ALUM ADAPTER x ML NPT
F300A	746041022730	3" F ALUM ADAPTER x ML NPT

WARNING: This product can expose you to chemicals including lead, which is known to the State of California to cause cancer or birth defects or other reproductive harm. For more information visit www.P65WARNINGS.ca.gov



POLYPROPYLENE Adapter x Male NPT

PART NUMBER	UPC	DESCRIPTION
F050P	746041341459	1/2" F POLYPROPYLENE ADAPTER x ML NPT
F075P	746041334888	3/4" F POLYPROPYLENE ADAPTER x ML NPT
F100P	746041334895	1" F POLYPROPYLENE ADAPTER x ML NPT
F125P	746041334901	1-1/4" F POLYPROPYLENE ADAPTER x ML NPT
F150P	746041334918	1-1/2" F POLYPROPYLENE ADAPTER x ML NPT
F200P	746041334925	2" F POLYPROPYLENE ADAPTER x ML NPT
F300P	746041334935	3" F POLYPROPYLENE ADAPTER x ML NPT

WARNING: This product can expose you to chemicals including DINP, which is known to the State of California to cause cancer or birth defects or other reproductive harm. For more information visit www.P65WARNINGS.ca.gov



CAM & GROOVE COUPLINGS - DC



ALUMINUM Dust Cap

PART NUMBER	UPC	DESCRIPTION
DC075A	746041060190	3/4" DC ALUM DUST CAP
DC100A	746041060206	1" DC ALUM DUST CAP
DC125A	746041060213	1-1/4" DC ALUM DUST CAP
DC150A	746041060220	1-1/2" DC ALUM DUST CAP
DC200A	746041023447	2" DC ALUM DUST CAP
DC300A	746041022792	3" DC ALUM DUST CAP

WARNING: This product can expose you to chemicals including lead, which is known to the State of California to cause cancer or birth defects or other reproductive harm. For more information visit www.P65WARNINGS.ca.gov



POLYPROPYLENE Dust Cap

PART NUMBER	UPC	DESCRIPTION
DC075P	746041060527	3/4" DC POLYPROPYLENE DUST CAP
DC100P	746041060534	1" DC POLYPROPYLENE DUST CAP
DC125P	746041060541	1-1/4" DC POLYPROPYLENE DUST CAP
DC150P	746041060558	1-1/2" DC POLYPROPYLENE DUST CAP
DC200P	746041060565	2" DC POLYPROPYLENE DUST CAP
DC300P	746041060572	3" DC POLYPROPYLENE DUST CAP

WARNING: This product can expose you to chemicals including DINP, which is known to the State of California to cause cancer or birth defects or other reproductive harm. For more information visit www.P65WARNINGS.ca.gov

CAM & GROOVE COUPLINGS - DP



ALUMINUM Dust Plug

PART NUMBER	UPC	DESCRIPTION
DP075A	746041060237	3/4" DP ALUM DUST PLUG
DP100A	746041060244	1" DP ALUM DUST PLUG
DP125A	746041023591	1-1/4" DP ALUM DUST PLUG
DP150A	746041060251	1-1/2" DP ALUM DUST PLUG
DP200A	746041022990	2" DP ALUM DUST PLUG
DP300A	746041022747	3" DP ALUM DUST PLUG

WARNING: This product can expose you to chemicals including lead, which is known to the State of California to cause cancer or birth defects or other reproductive harm. For more information visit www.P65WARNINGS.ca.gov



POLYPROPYLENE Dust Plug

PART NUMBER	UPC	DESCRIPTION
DP075P	746041060589	3/4" DP POLYPROPYLENE DUST PLUG
DP100P	746041060596	1" DP POLYPROPYLENE DUST PLUG
DP125P	746041334857	1-1/4" DP POLYPROPYLENE DUST PLUG
DP150P	746041060602	1-1/2" DP POLYPROPYLENE DUST PLUG
DP200P	746041060619	2" DP POLYPROPYLENE DUST PLUG
DP300P	746041060626	3" DP POLYPROPYLENE DUST PLUG

WARNING: This product can expose you to chemicals including DINP, which is known to the State of California to cause cancer or birth defects or other reproductive harm. For more information visit www.P65WARNINGS.ca.gov

PIN LUG SHANK COUPLINGS



PART NUMBER	UPC	DESCRIPTION
AB150	746041059484	1-1/2" ALUM W BRASS SWIVEL PIN LUG SET (MxF)
AB200	746041054397	2" ALUM W BRASS SWIVEL PIN LUG SET (MxF)
AB300	746041054403	3" ALUM W BRASS SWIVEL PIN LUG SET (MxF)
AB400	746041059491	4" ALUM W BRASS SWIVEL PIN LUG SET (MxF)
AB150F	746041059927	1-1/2" ALUM W BRASS SWIVEL FEM
AB200F	746041059934	2" ALUM W BRASS SWIVEL FEM
AB300F	746041059941	3" ALUM W BRASS SWIVEL FEM
AB400F	746041059958	4" ALUM W BRASS SWIVEL FEM

WARNING: This product can expose you to chemicals including lead, which is known to the State of California to cause cancer or birth defects or other reproductive harm. For more information visit www.P65WARNINGS.ca.gov

RUBBER GASKETS

PART NUMBER	UPC	DESCRIPTION
HW150-4P	746041428952	RUBBER GASKETS 1-1/2"
HW200-4P	746041428969	RUBBER GASKETS 2"
HW300-4P	746041428976	RUBBER GASKETS 3"

WARNING: This product can expose you to chemicals including carbon black, which is known to the State of California to cause cancer or birth defects or other reproductive harm. For more information visit www.P65WARNINGS.ca.gov



COMBINATION HOSE NIPPLE

UNPLATED

PART NUMBER	UPC	DESCRIPTION
CN050	746041059712	1/2" COMBINATION HOSE NIPPLE, UNPLATED
CN075	746041023249	3/4" COMBINATION HOSE NIPPLE, UNPLATED
CN100	746041023256	1" COMBINATION HOSE NIPPLE, UNPLATED
CN125	746041023263	1-1/4" COMBINATION HOSE NIPPLE, UNPLATED
CN150	746041059750	1-1/2" COMBINATION HOSE NIPPLE, UNPLATED
CN200	746041023270	2" COMBINATION HOSE NIPPLE, UNPLATED
CN250	746041060022	2-1/2" COMBINATION HOSE NIPPLE, UNPLATED
CN300	746041060046	3" COMBINATION HOSE NIPPLE, UNPLATED
CN400	746041059729	4" COMBINATION HOSE NIPPLE, UNPLATED

WARNING: This product can expose you to chemicals including lead, which is known to the State of California to cause cancer or birth defects or other reproductive harm. For more information visit www.P65WARNINGS.ca.gov



PLATED

PART NUMBER	UPC	DESCRIPTION
CN050P	746041059507	1/2" COMBINATION HOSE NIPPLE, PLATED
CN075P	746041054380	3/4" COMBINATION HOSE NIPPLE, PLATED
CN100P	746041054410	1" COMBINATION HOSE NIPPLE, PLATED
CN125P	746041059545	1-1/4" COMBINATION HOSE NIPPLE, PLATED
CN150P	746041022761	1-1/2" COMBINATION HOSE NIPPLE, PLATED
CN200P	746041022808	2" COMBINATION HOSE NIPPLE, PLATED
CN250P	746041059583	2-1/2" COMBINATION HOSE NIPPLE, PLATED
CN300P	746041022778	3" COMBINATION HOSE NIPPLE, PLATED
CN400P	746041023430	4" COMBINATION HOSE NIPPLE, PLATED

WARNING: This product can expose you to chemicals including lead, which is known to the State of California to cause cancer or birth defects or other reproductive harm. For more information visit www.P65WARNINGS.ca.gov



POLYPROPYLENE

PART NUMBER	UPC	DESCRIPTION
CN050PP	746041059514	1/2" COMBINATION HOSE NIPPLE, POLYPROPYLENE
CN075PP	746041059521	3/4" COMBINATION HOSE NIPPLE, POLYPROPYLENE
CN100PP	746041059538	1" COMBINATION HOSE NIPPLE, POLYPROPYLENE
CN125PP	746041059552	1-1/4" COMBINATION HOSE NIPPLE, POLYPROPYLENE
CN150PP	746041059569	1-1/2" COMBINATION HOSE NIPPLE, POLYPROPYLENE
CN200PP	746041059576	2" COMBINATION HOSE NIPPLE, POLYPROPYLENE
CN250PP	746041059590	2-1/2" COMBINATION HOSE NIPPLE, POLYPROPYLENE
CN300PP	746041059606	3" COMBINATION HOSE NIPPLE, POLYPROPYLENE
CN400PP	746041059613	4" COMBINATION HOSE NIPPLE, POLYPROPYLENE

WARNING: This product can expose you to chemicals including DINP, which is known to the State of California to cause cancer or birth defects or other reproductive harm. For more information visit www.P65WARNINGS.ca.gov



BRAIDED PVC TUBING



TUBE: PVC, crystal clear, non-toxic, FDA Grade
REINFORCEMENT: Synthetic braid
COVER: PVC, crystal clear, non-toxic, FDA Grade
BRANDING: Jason logo WP (PSI) FDA Non-Toxic Country of Origin
TEMPERATURE RANGE: -14°F (-26°C) to +140°F (+60°C)
FEATURES: One piece long length coils, smooth as glass tube.
 Resists chemical, ozone and weather deterioration.
APPLICATION: Food and beverage dispensing, potable water, air breathing lines, packaging and equipment, lube lines and other visual flow applications.

PART NUMBER	UPC	DESCRIPTION
4511-0251-100	746041341039	1/4" x 100' CLEAR, SHRINK WRAP W/ LABEL, 250 PSI
4511-0381-100	746041053260	3/8" x 100' CLEAR, SHRINK WRAP W/ LABEL, 200 PSI
4511-0501-100	746041053192	1/2" x 100' CLEAR, SHRINK WRAP W/ LABEL, 150 PSI
4511-0631-100	746041053208	5/8" x 100' CLEAR, SHRINK WRAP W/ LABEL, 150 PSI
4511-0751-100	746041053185	3/4" x 100' CLEAR, SHRINK WRAP W/ LABEL, 150 PSI
4511-1001-100	746041053215	1" x 100' CLEAR, SHRINK WRAP W/ LABEL, 125 PSI

WARNING: This product can expose you to chemicals including DINP, which is known to the State of California to cause cancer or birth defects or other reproductive harm. For more information visit www.P65WARNINGS.ca.gov

EVA TUBING



TUBE: Ethylene vinyl acetate
REINFORCEMENT: N/A
TEMPERATURE RANGE: -50°F (-46°C) to +125°F (+52°C)
FEATURES: 25', 50' Shrink-wrapped. 100' boxed. 500' bulk
APPLICATION: To handle common herbicides/insecticide solutions. Used for application of anhydrous ammonia, aqua ammonia, phosphate and all liquid fertilizers. Will not crack or harden, even in freezing temperatures.

PART NUMBER	UPC	DESCRIPTION
4507-0406-500	746041062347	1/4" x 1/8" WALL x 500' REEL
4507-0610-0025	746041058548	3/8" x 1/8" WALL x 25' SHRINK-WRAPPED COIL
4507-0610-0050	746041059675	3/8" x 1/8" WALL x 50' SHRINK-WRAPPED COIL
4507-0610-0100	746041062163	3/8" x 1/8" WALL x 100' BOXED
4507-0610-500	746041062354	3/8" x 1/8" WALL x 500' REEL
4507-0812-0025	746041058555	1/2" x 1/8" WALL x 25' SHRINK-WRAPPED COIL
4507-0812-0050	746041059682	1/2" x 1/8" WALL x 50' SHRINK-WRAPPED COIL
4507-0812-0100	746041062170	1/2" x 1/8" WALL x 100' BOXED
4507-0812-500	746041062361	1/2" x 1/8" WALL x 500' REEL
4507-1014-0025	746041057183	5/8" x 1/8" WALL x 25' SHRINK-WRAPPED COIL
4507-1014-0050	746041057190	5/8" x 1/8" WALL x 50' SHRINK-WRAPPED COIL
4507-1014-0100	746041059705	5/8" x 1/8" WALL x 100' BOXED
4507-1014-250	746041062378	5/8" x 1/8" WALL x 250' REEL
4507-1214-0025	746041057015	3/4" x 1/8" WALL x 25' SHRINK-WRAPPED COIL
4507-1214-0050	746041057053	3/4" x 1/8" WALL x 50' SHRINK-WRAPPED COIL
4507-1214-0100	746041057107	3/4" x 1/8" WALL x 100' BOXED
4507-1214-250	746041062385	3/4" x 1/8" WALL x 250' REEL
4507-1620-0025	746041057022	1" x 5/32" WALL x 25' SHRINK-WRAPPED COIL
4507-1620-0050	746041057060	1" x 5/32" WALL x 50' SHRINK-WRAPPED COIL
4507-1620-0100	746041057114	1" x 5/32" WALL x 100' BOXED
4507-1620-250	746041062392	1" x 5/32" WALL x 250' REEL

WARNING: This product can expose you to chemicals including DINP, which is known to the State of California to cause cancer or birth defects or other reproductive harm. For more information visit www.P65WARNINGS.ca.gov

EPDM SPRAYER HOSE

TUBE: EPDM

REINFORCEMENT: Polyester

WORKING PRESSURE: 200 PSI

TEMPERATURE RANGE: -40°F (-40°C) to +180°F (+82°C)

APPLICATION: Resists heat, sunlight, ozone and weathering.

Lightweight and flexible. Accommodates many AG chemicals, including LASSO® herbicide.

Not suitable for use with anhydrous ammonia or the transfer of petroleum products.



WARNING: This product can expose you to chemicals including carbon black, which is known to the State of California to cause cancer or birth defects or other reproductive harm. For more information visit www.P65WARNINGS.ca.gov



PART NUMBER	UPC	SIZE	SPIRAL
4298-0254-0010	746041437053	1/4" ID x 10'	2
4298-0254-0025	746041437107	1/4" ID x 25'	2
4298-0254-0050	746041437114	1/4" ID x 50'	2
4298-0254-0100	746041437121	1/4" ID x 100'	2
4298-0254-750	746041437138	1/4" ID x 750'	2
4298-0504-0010	746041437046	1/2" ID x 10'	2
4298-0504-0025	746041437183	1/2" ID x 25'	2
4298-0504-0050	746041437190	1/2" ID x 50'	2
4298-0504-0100	746041437206	1/2" ID x 100'	2
4298-0504-750	746041437213	1/2" ID x 750'	2
4298-0754-0010	746041437084	3/4" ID x 10'	4
4298-0754-0025	746041437268	3/4" ID x 25'	4
4298-0754-0050	746041437275	3/4" ID x 50'	4
4298-0754-500	746041437282	3/4" ID x 500'	4

PART NUMBER	UPC	SIZE	SPIRAL
4298-0374-0010	746041437060	3/8" ID x 10'	2
4298-0374-0025	746041437145	3/8" ID x 25'	2
4298-0374-0050	746041437152	3/8" ID x 50'	2
4298-0374-0100	746041437169	3/8" ID x 100'	2
4298-0374-750	746041437176	3/8" ID x 750'	2
4298-0624-0010	746041437077	5/8" ID x 10'	2
4298-0624-0025	746041437220	5/8" ID x 25'	2
4298-0624-0050	746041437237	5/8" ID x 50'	2
4298-0624-0100	746041437244	5/8" ID x 100'	2
4298-0624-500	746041437251	5/8" ID x 500'	2
4298-1004-0010	746041437091	1" ID x 10'	4
4298-1004-0025	746041437299	1" ID x 25'	4
4298-1004-0050	746041437305	1" ID x 50'	4
4298-1004-500	746041437312	1" ID x 500'	4

*500' and 750' coils contain no more than two pieces.



TERMS, CONDITIONS AND LIMITED WARRANTY OF SALE

All prices, terms and conditions of sale are subject to change without prior notice. Buyer agrees to all terms and conditions of seller upon the placement of any and all purchase orders.

GENERAL

- All orders are subject to a minimum charge of \$25.00.
- All claims must be made within seven (7) days of receipt of merchandise.
- The company reserves the right at all times to reject any and all orders for any reason.

PAYMENT TERMS

- Net 30 days (to approved and qualified accounts).
- We reserve the right to hold shipments against past due accounts.
- Seller may require full or partial payment in advance if, in its sole judgement, the financial condition of the buyer does not justify the terms specified.
- All past due accounts are subject to a late payment charge of 1.5% per month, or maximum allowed by law if different, along with the expenses incidental to collection including reasonable attorney's fees.
- Returned checks are subject to a minimum \$50.00 charge.

FREIGHT TERMS

- Collect.
- Orders with different numbers and dates may not be combined to make freight allowance.
- Prepaid orders requiring immediate delivery that must be shipped from different Jason locations may be subject to a freight surcharge. Such determination will be made at the time of order.
- Backorders will be shipped in the most practical fashion with charges consistent with our freight policy established with the original order.

ACCEPTANCE, ALTERATION AND CANCELLATION OF ORDERS

Orders for other than standard items or standard lengths may not be cancelled after purchase has been committed, production scheduled or any costs incurred.

RETURN OF DEFECTIVE MERCHANDISE

Defective or failed material to be held at the buyer's premises until authorization has been granted by seller to return or dispose of merchandise. Merchandise to be returned for final inspection must be returned Freight Prepaid in the most economical way. Credit will be issued for material found to be defective upon our inspection based on prices at time of purchase.

MERCHANDISE SHIPPED IN ERROR

Buyer must notify seller immediately on any merchandise shipped in error. Upon notification, merchandise is to be returned to seller either via truck on a Freight Collect basis, via carrier of our choice, or via UPS on a Freight Prepaid basis. Buyer will be reimbursed for cost of merchandise, plus any additional freight which may have been incurred due to shipping error.

MERCHANDISE ORDERED IN ERROR

Standard packaged merchandise only may be returned, provided that the merchandise is in the original buyer's possession not more than 30 days. If merchandise is accepted for return, merchandise must be returned Freight Prepaid, and buyer will be charged a minimum of 15% rehandling charge, plus a chargeback for outbound freight charges if the original order was shipped prepaid. Returns are not accepted for any merchandise that is specifically manufactured to meet the buyer's requirement of either specifications or large quantity.

DELIVERY, DAMAGES, SHORTAGES

Delivery to the initial common carrier shall constitute the delivery to the buyer. Our responsibility, insofar as transportation risks are concerned, ceases upon the delivery of the merchandise in good condition to such a carrier, and all the merchandise shall be shipped at the buyer's risk.

GOODS DAMAGED IN SHIPMENT

Upon receipt of shipment, any evidence of damage to original shipping package must be reported by the receiving party and a claim made with the delivering carrier upon receipt of shipment.

CONCEALED DAMAGE

Any evidence of damage to material shipped, upon the opening of the original shipping package, must be reported by the receiving party to and a claim made with the delivering carrier without delay.



LIMITED WARRANTY

The merchandise or products sold or distributed by Jason Industrial are warranted to our customers to be free from defects in material and workmanship at the time of shipment by us. All warranty claims shall be made within 90 days after we have shipped the merchandise. Our liability hereunder is limited to the purchase price of any merchandise proved defective, or, at our option, to the replacement of such merchandise upon its authorized return to us.

THIS WARRANTY IS IN LIEU OF AND EXCLUDES ALL OTHER WARRANTIES, EXPRESSED, IMPLIED, STATUTORY, OR OTHERWISE CREATED UNDER APPLICABLE LAW INCLUDING, BUT NOT LIMITED TO, THE WARRANTY OF MERCHANT ABILITY AND THE WARRANTY OF FITNESS FOR A PARTICULAR PURPOSE. IN NO EVENT SHALL WE BE LIABLE FOR SPECIAL, INCIDENTAL, OR CONSEQUENTIAL DAMAGES, INCLUDING LOSS OF PROFITS.

Copyright Notice: Jason Industrial copyright. All rights reserved. Jason Industrial is and shall remain the owner of all rights on drawings, technical specifications and any other information contained in the present catalog or otherwise communicated by Jason Industrial to the customer. The customer shall not disclose such information to third parties or use such information for purposes different from the definition of the order to Jason Industrial, unless upon prior written authorization of Jason Industrial.



Customer Service
800.527.1247

BELARUS

Minsk
Phone +375 17 2802486
Info.by@megadynegroup.com

BRAZIL

Sorocaba
Phone +55 15 2101 7700
Info.br@megadynegroup.com

CANADA

Edmonton
Phone +1 780 461 4400
Info.ca@megadynegroup.com

Montreal

Phone +1 514 31 2341
Info.ca@megadynegroup.com

Toronto

Phone +1 905 602 4400
Info.ca@megadynegroup.com

CHINA

Beijing
Phone +86 10 8150 7478
info.cn@megadynegroup.com

Foshan

Phone +86 757 83815530
info.cn@megadynegroup.com

Fujian

Phone +86 595 8816 0309
info.cn@megadynegroup.com

Ningbo*

Phone +86 574 8650 2886
info.cn@megadynegroup.com

Qingdao*

Phone +86 532 8765 2117
info.cn@megadynegroup.com

Shanghai

Phone +86 21 5447 1473
info.cn@megadynegroup.com

Shenyang

Phone +86 24 2572 3238
info.cn@megadynegroup.com

COLOMBIA

Bogotá
Phone +57 (1) 471 0503
Info.co@megadynegroup.com

Cartagena

Phone +57 (5) 672 997
Info.co@megadynegroup.com

CZECH REPUBLIC

Prague
Phone +420 2 8481 7181
Info.cz@megadynegroup.com

FRANCE

Paris
Phone +33 1 6079 8200
info.fr@megadynegroup.com

St. Jean De Maurienne*

Phone +33 4 7964 0613
info.fr@megadynegroup.com

GERMANY

Borchen
Phone +49 5251 8735 0
info.de@megadynegroup.com

Elchingen*

Phone +49 7308 9665 0
info.de@megadynegroup.com

HUNGARY

Budapest
Phone +36 23 428 628
info.hu@megadynegroup.com

INDIA

Chennai*
Phone +91 98841 81175
info.in@megadynegroup.com

ISRAEL

Caesarea
Phone +972 4 6371485
sales@megabelt.co.il

ITALY

Turin*
Phone +39 011 926 8052
info@megadynegroup.com

Milan*

Phone +39 039 689 601
info.it@megadynegroup.com

Pescara

Phone +39 085 9700547
info.it@megadynegroup.com

Venice

Phone: +39 041 929 367
info.it@megadynegroup.com

MEXICO

Mexico C.P.
Phone +52 55 5587 3680
info.mx@megadynegroup.com

PERU

Lima
Phone +51 713 0069
info.pe@megadynegroup.com

POLAND

Bydgoszcz*
Phone +48 52 348 77 12
info.pl@megadynegroup.com

SOUTH AFRICA

Johannesburg
Phone +27 (0)12 661 1652
info.za@megadynegroup.com

Cape Town

Phone +27 (0)21 982 0772
info.za@megadynegroup.com

SPAIN

Barcelona*
Phone +34 933 774 441
www.avetm.com

Vilanova*

Phone +34 93 811 5450
info.es@megadynegroup.com

SWEDEN

Kristianstad
Phone +46 10 1309600
info.se@megadynegroup.com

THAILAND

Bangkok
Phone: +66 (0) 27115477
info.th@megadynegroup.com

TURKEY

Izmir*
Phone +90 232 877 07 00
info.tr@megadynegroup.com

U.K.

Birmingham
Phone: +44 1384 215 021
info.uk@megadynegroup.com

U.S.A

California
Phone +1 323 265 8061
info.us@megadynegroup.com

Florida

Phone +1 813 241 4111
info.us@megadynegroup.com

Georgia*

Phone +1 770 887 9725
info.us@megadynegroup.com

Illinois

Phone +1 630 752 0600
info.us@megadynegroup.com

New Jersey Americas HQ

Phone +1 973 227 4904
info.us@megadynegroup.com

New York*

Phone +1 716 667 7450
info.us@megadynegroup.com

North Carolina*

Phone +1 704 583 5388
info.us@megadynegroup.com

Oregon

Phone +1 503 231 7224
info.us@megadynegroup.com

Texas

Phone +1 972 438 6992
info.us@megadynegroup.com

www.jasonindustrial.com

* Manufacturing locations

